

Gateway TP-A60W/ TP-A60G

# SERVICE GUIDE



## Revision History

Refer to the table below for the updates made to this service guide.

Date	Chapter	Updates

Service guide files and updates are available on the ACER/CSD Website. For more information, go to <http://csd.acer.com.tw>. The information in this guide is subject to change without notice.

## Copyright

Copyright © 2011 by Gateway Incorporated. All rights reserved. No part of this publication may be reproduced, transmitted, transcribed, stored in a retrieval system, or translated into any language or computer language, in any form or by any means, electronic, mechanical, magnetic, optical, chemical, manual or otherwise, without the prior written permission of Gateway Incorporated.

## Disclaimer

The information in this guide is subject to change without notice.

There are no representations or warranties, either expressed or implied, with respect to the contents hereof and specifically disclaims any warranties of merchantability or fitness for any particular purpose. The software described in this manual is sold or licensed "as is". Should the programs prove defective following their purchase, the buyer (not the manufacturer, distributor, or its dealer) assumes the entire cost of all necessary servicing, repair, and any incidental or consequential damages resulting from any defect in the software.

## Conventions

The following conventions are used in this manual:

### ⚠ WARNING:

Indicates a potential for personal injury.

### ⚠ CAUTION:

Indicates a potential loss of data or damage to equipment.

### + IMPORTANT:

Indicates information that is important to know for the proper completion of a procedure, choice of an option, or completing a task.

**N/A:** Indicates that a component or a procedure is not applicable to this model.

### ⇒ NOTE:

Follow local regulations for battery and circuit board disposal. Batteries and Circuit Boards >10 cm<sup>2</sup> have been highlighted with a yellow rectangle.

The following typographical conventions are used in this document:

- Book titles, directory names, file names, path names, and program/process names are shown in *italics*.

Example:

the *DRS5 User's Guide*  
*/usr/local/bin/fd*  
the */TPH15spool\_M* program

- Computer output (text that represents information displayed on a computer screen, such as menus, prompts, responses to input, and error messages) are shown in constant width.

Example:

```
[01] The server has been stopped
```

- User input (text that represents information entered by a computer user, such as command names, option letters, and words) are shown in constant width bold.

Variables contained within user input are shown in angle brackets (< >).

Example:

At the prompt, type run **<file name> -m**

- Keyboard keys are shown in ***bold italics***.

Example:

After entering data, press ***Enter***.

# General Information

---

This service guide provides all technical information relating to the basic configuration for Gateway global product offering. To better fit local market requirements and enhance product competitiveness, your regional office may have decided to extend the functionality of a machine (such as add-on cards, modems, or extra memory capabilities). These localized features are not covered in this generic service guide. In such cases, contact your regional offices or the responsible personnel/channel to provide further technical details.

When ordering FRU parts:

Check the most up-to-date information available on your regional Web or channel. If, for whatever reason, a part number change is made, it may not be noted in this printed service guide.

Acer-authorized Service Providers:

Your Acer office may have a different part number code than those given in the FRU list in this service guide. The list provided by your regional Acer office must be used to order FRU parts for repair and service of customer machines.



# CHAPTER 1

## Hardware Specifications

---

<b>Features</b> .....	<b>1-3</b>
Operation System .....	1-3
Platform .....	1-3
System Memory .....	1-3
Display .....	1-3
Graphics .....	1-3
Audio Subsystem .....	1-3
Communication .....	1-4
Special Keys and Controls .....	1-4
I/O Ports .....	1-5
Dimensions and Weight .....	1-5
Power Adapter and Battery .....	1-5
Environment .....	1-5
Optional Items .....	1-6
<b>Notebook Tour</b> .....	<b>1-7</b>
Front View .....	1-7
Back View .....	1-8
Left View .....	1-9
Bottom View .....	1-10
Top View .....	1-11
Right View .....	1-12
<b>System Block Diagram</b> .....	<b>1-13</b>
<b>Specification Tables</b> .....	<b>1-14</b>
Computer specifications .....	1-14
System Board Major Chips .....	1-15
Processor .....	1-15
Processor Specifications .....	1-16
System Memory .....	1-16
Video Interface (Integrated) .....	1-17
Embedded MultiMediaCard (AVL components) .....	1-20
LED 10.1" .....	1-21
Display Supported Resolution (LCD) .....	1-22
Graphics Controller .....	1-22
Display Supported Resolution (GPU) .....	1-22
Bluetooth Interface .....	1-22
Bluetooth Module .....	1-22
Front Camera .....	1-23
Rear Camera .....	1-23
Mini Card .....	1-23
3G Card .....	1-23
Audio Codec and Amplifier .....	1-24
Audio Interface .....	1-24
Wireless Module 802.11b/g/n .....	1-25

Battery . . . . .	1-25
VRAM . . . . .	1-25
USB Port . . . . .	1-25
HDMI Port . . . . .	1-25
AC Adapter . . . . .	1-26
System Power Management . . . . .	1-26
Card Reader . . . . .	1-26
System LED Indicator . . . . .	1-26
System DMA Specification . . . . .	1-27

## **CHAPTER 2**

### **Diagnostic Utilities**

---

<b>Introduction . . . . .</b>	<b>2-3</b>
<b>NGA EUU Installation Procedure . . . . .</b>	<b>2-3</b>
<b>Picasso Diagnostic Tool . . . . .</b>	<b>2-11</b>

## **CHAPTER 3**

### **Maintenance Procedures**

---

<b>Introduction . . . . .</b>	<b>3-3</b>
<b>General Information . . . . .</b>	<b>3-3</b>
<b>Recommended Equipment . . . . .</b>	<b>3-3</b>
<b>Maintenance Flowchart . . . . .</b>	<b>3-4</b>
<b>Getting Started . . . . .</b>	<b>3-5</b>
SIM/Micro-SD Card Removal . . . . .	3-6
SIM/Micro-SD Card Installation . . . . .	3-8
Lower Case Removal . . . . .	3-9
Lower Case Installation . . . . .	3-14
DC-In Cable Removal . . . . .	3-16
DC-In Cable Installation . . . . .	3-18
Battery Removal . . . . .	3-19
Battery Installation . . . . .	3-20
3G Module Removal . . . . .	3-21
3G Module Installation . . . . .	3-23
Docking Board Removal . . . . .	3-24
Docking Board Installation . . . . .	3-26
GPS Antenna Removal . . . . .	3-28
GPS Antenna Installation . . . . .	3-29
Mainboard Removal . . . . .	3-30
Mainboard Installation . . . . .	3-32
Rear CCD Removal . . . . .	3-35
Rear CCD Installation . . . . .	3-37
Front CCD Removal . . . . .	3-38

Front CCD Installation . . . . .	3-38
Two-Piece Microphone Removal . . . . .	3-39
Two-Piece Microphone Installation . . . . .	3-39
Speakers Removal . . . . .	3-41
Speakers Installation . . . . .	3-41
USB Module Removal . . . . .	3-42
USB Module Installation . . . . .	3-43
LCD Support Plate Removal . . . . .	3-44
LCD Support Plate Installation . . . . .	3-47
Control Board Removal . . . . .	3-48
Control Board Installation . . . . .	3-49
3G Antenna Removal . . . . .	3-51
3G Antenna Installation . . . . .	3-51
WLAN Antenna Removal . . . . .	3-53
WLAN Antenna Installation . . . . .	3-53

## **CHAPTER 4**

### **Troubleshooting**

---

<b>Introduction . . . . .</b>	<b>4-3</b>
<b>General Information . . . . .</b>	<b>4-3</b>
Power On Issues . . . . .	4-4
No Display Issues . . . . .	4-5
LCD Picture Failure . . . . .	4-6
Touch Screen Failure . . . . .	4-7
Internal Speaker Failure . . . . .	4-8
Internal Microphone Failure . . . . .	4-9
USB Failure . . . . .	4-10
Front Camera Failure . . . . .	4-11
Back Camera Failure . . . . .	4-12
P-Sensor Failure . . . . .	4-13
3G Function Failure . . . . .	4-14
Wireless Function Test Failure . . . . .	4-15
GPS Function Test Failure (Wi-Fi SKU) . . . . .	4-16
GPS Function Test Failure (3G SKU) . . . . .	4-17
Docking Station Test Failure . . . . .	4-18
Other Functions Failure . . . . .	4-19

## **CHAPTER 5**

### **Jumper and Connector Locations**

---

<b>Mainboard Top . . . . .</b>	<b>5-3</b>
<b>Mainboard Bottom . . . . .</b>	<b>5-4</b>

## **CHAPTER 6**

### **Field Replaceable Unit List**

---

<b>Exploded Diagrams</b> .....	<b>6-4</b>
Main Assembly .....	6-4
LCD Exploded Diagram .....	6-8
<b>FRU List</b> .....	<b>6-9</b>
<b>Screw List</b> .....	<b>6-15</b>

## **CHAPTER 7**

### **Model Definition and Configuration**

---

<b>TP-A60W</b> .....	<b>7-3</b>
----------------------	------------

## **CHAPTER 8**

### **Test Compatible Components**

---

<b>Android OS Environment Test</b> .....	<b>8-4</b>
TP-A60W/ TP-A60G .....	8-4

## **CHAPTER 9**

### **Online Support Information**

---

<b>Introduction</b> .....	<b>9-3</b>
---------------------------	------------

# CHAPTER 1

## Hardware Specifications

---

<b>Features</b> .....	<b>1-3</b>
Operation System .....	1-3
Platform .....	1-3
System Memory .....	1-3
Display .....	1-3
Graphics .....	1-3
Audio Subsystem .....	1-3
Communication .....	1-4
Special Keys and Controls .....	1-4
I/O Ports .....	1-5
Dimensions and Weight .....	1-5
Power Adapter and Battery .....	1-5
Environment .....	1-5
Optional Items .....	1-6
<b>Notebook Tour</b> .....	<b>1-7</b>
Front View .....	1-7
Rear View .....	1-8
Top View .....	1-9
Left View .....	1-10
Right View .....	1-11
Bottom View .....	1-12
<b>System Block Diagram</b> .....	<b>1-13</b>
<b>Specification Tables</b> .....	<b>1-14</b>
Computer specifications .....	1-14
Processor .....	1-15
Processor Specifications .....	1-16
System Memory .....	1-16
Video Interface (Integrated) .....	1-17
Graphics Controller .....	1-22
Display Supported Resolution (GPU) .....	1-22
Bluetooth Interface .....	1-22
Bluetooth Module .....	1-22
Rear Camera .....	1-23
Mini Card .....	1-23
3G Card .....	1-23
Audio Interface .....	1-24
Battery .....	1-25
VRAM .....	1-25
USB Port .....	1-25
HDMI Port .....	1-25
AC Adapter .....	1-26
System Power Management .....	1-26
Card Reader .....	1-26
System LED Indicator .....	1-26
System DMA Specification .....	1-27

# Hardware Specifications and Configurations

---

## Features

---

The following is a summary of the computer's many features:

### Operation System

- Android Honeycomb

### Platform

- Tegra 250 Dual cortex A9, 1GHz
- GPU Ultra Low Power GeForce® GPU

### System Memory

- RAM: LP DDR2 1GB
- eMMC: eMMC: 16G / 32G two SKU (SanDisk / Samsung)

### Display

#### LCM

- 10.1" WXGA, 262K LCM (1280\*800 AUO)
  - Wide view angle
  - LVDS interface

### Graphics

- ULP GeForce

### Audio Subsystem

- Dual analog Microphone (Beam-forming, Noise /echo cancellation)
- Dual Speaker
- 3.5mm Audio Jack 4ring (with Mic)
- Dolby mobile

## Storage Subsystem (N/A)

## Optical Media Drive (N/A)

## Privacy Control (N/A)

## Communication

### Camera (Webcam)

- Main camera: 5M Camera with Auto focus
  - with flash lights (single LED)
- Second camera: 2M FF

### WLAN

- 3G Module HUAWEI EM770W (with GPS/AGPS)
  - UMTS /WCDMA 1, 2, 5, 8 2100/1900/850/900
  - HSPA: HSDPA up to 7.2 Mbps/ HSUPA up to 5.76Mbps
  - GSM/GPRS/EDGE 850MHz / 900MHz / 1800Mhz / 1900Mhz
- 3G Module Ericsson F5521gw (with GPS/AGPS)
  - UMTS /WCDMA 1, 2, 5, 8 2100/1900/850/900
  - HSPA+: HSDPA up to 21Mbps/ HSUPA up to 5.76Mbps
  - GSM/GPRS/EDGE 850MHz / 900MHz / 1800Mhz / 1900Mhz
- 3G Module HUAWEI EM820W (with GPS/AGPS)
  - UMTS /WCDMA 1, 2, 5, 8 2100/1900/850/900
  - HSPA+: HSDPA up to 21Mbps / HSUPA up to 5.76Mbps
  - GSM/GPRS/EDGE 850MHz / 900MHz / 1800Mhz / 1900Mhz
- 802.11 b/g/n WiFi (802.11n 2.4GHz only)

### WPAN

- Bluetooth® 2.1+EDR

### GPS/A GPS

- WIFI SKU: Broadcom - stand alone, not support A-GPS
- 3G SKU: on 3G module, support GPS and A-GPS

## Special Keys and Controls

- Capacitive Multi-Touch Screen (Real 4 touch, up to 10)
- Function buttons
  - Side (mechanical key):
    - Volume Up, Volume Down, screen lock
    - Power:with back light-white/orange
- Sensors
  - G-Sensor
  - E-Compass



- L Sensor
- Gyro-meter
- Power reset hole

## I/O Ports

- MicroSD memory card up to 32G (SDHC 2.0 compatible)
- HDMI D-type (support Dual Display)
- USB
  - Micro USB 2.0 type B for Client
  - USB 2.0 Host
- Docking (Supports Charging, Audio out and IR remote control; does not support HDMI)

## Dimensions and Weight

### Dimensions

- 260 (L) x 179 (W) x 14 (H) mm

### Weight

- WIFI SKU: 740g
- 3G SKU: 750g

## Power Adapter and Battery

- Rohs compliance
- WEEE compliance
- Hologen free, at least PVC free
- SMT Green process

### Battery

- Rechargeable Lithium-ion polymer battery
- Capacity: 24.1Wh (3260mAh cell, 2S1P)

### Power Adapter

- Voltage range/frequency: 100 ~ 240V AC, 50/60 Hz
- DC output: 12V and 1.5 A, 18W

## Environment

### Temperature:

- Operating: 0°C to 50°C (32°F to 122°F)
- Non-operating: -20°C to 60°C (-4°F to 140°F)

### Humidity (non-condensing):

- Operating: 10% to 90%
- Non-operating: 5% to 95%

## Optional Items

- Micro SD Card
- Dock with IR remote control
- HDMI Cable
- Pouch

### **In Box**

- USB Cable
- Charger + Plug
- QSG

### **⇒ NOTE:**

Protective film is not available

Warranty (N/A)

Software (N/A)

# Notebook Tour

---

## Front View

---



**Figure 1-1. Front View**

**Table 1-1. Front View**

#	Icon	Item	Description
1		Touchscreen	10.1-inch, 1280 x 800 pixel capacitive touchscreen.
2		Front-facing Camera	A 2-megapixel camera for video chatting and self-portrait images.
3		Light Sensor	Detects ambient light and automatically adjusts the screen brightness.

## Back View

---



**Figure 1-2. Back View**

**Table 1-2. Back View**

#	Icon	Item	Description
1		LED Flash	Lights to illuminate images.
2		5 MP Camera	A 5-megapixel camera for taking highresolution images.
3		Speakers	Emits stereo audio.

## Left View




---



---

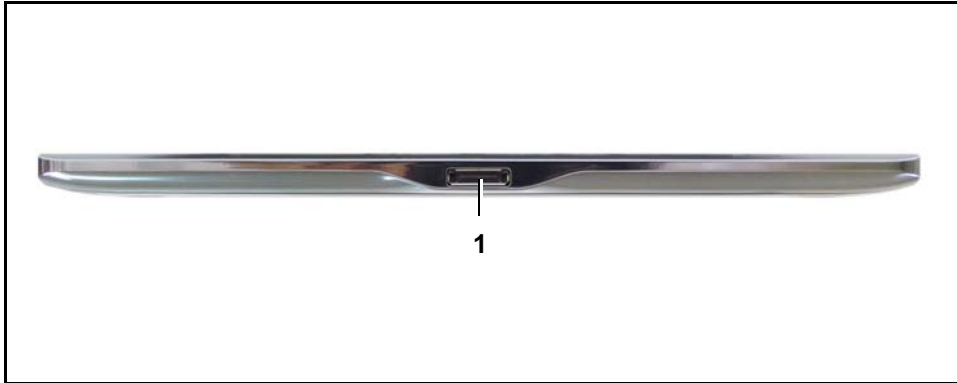
**Figure 1-3. Left View**

**Table 1-3. Left View**

#	Icon	Item	Description
1		HDMI Micro (Type D) Port	Connects to an HDMI cable with a Type D connector.
2		3.5 mm Headphone Jack	Connects to stereo headphones.
3		Power Button	Long press to turn the tablet on, press briefly to turn the screen on/off or enter sleep mode; press and hold to turn the tablet off.

## Bottom View

---



---

**Figure 1-4. Bottom View**

**Table 1-4. Bottom View**

#	Icon	Item	Description
1		Docking port	Connects your tablet to the dock accessory.


## Top View

---



**Figure 1-5. Top View**

**Table 1-5. Top View**

#	Icon	Item	Description
1		Volume Control Key	Increases and decreases the tablet volume.
2		Screen Rotation Lock Switch	Use this switch to lock the screen rotation or allow the screen to match the tablet's orientation.
3		Card Slot Cover	Insert a microSD card into the slot under this cover. The SIM card (only for Wi-Fi+3G models) slot allows you to access the Internet if you have a cellular data subscription.

## Right View




---



---

Figure 1-6. Right View

Table 1-6. Right View

#	Icon	Item	Description
1		Reset Button	Insert a small thin object (such as a paperclip) to reset power to the tablet.
2		USB Port (Host)	Connects USB devices to your tablet.
3		Micro USB port (Slave)	Connects to a computer with a USB cable.
4		DC-in Jack	Connects to the DC power supply.



# System Block Diagram

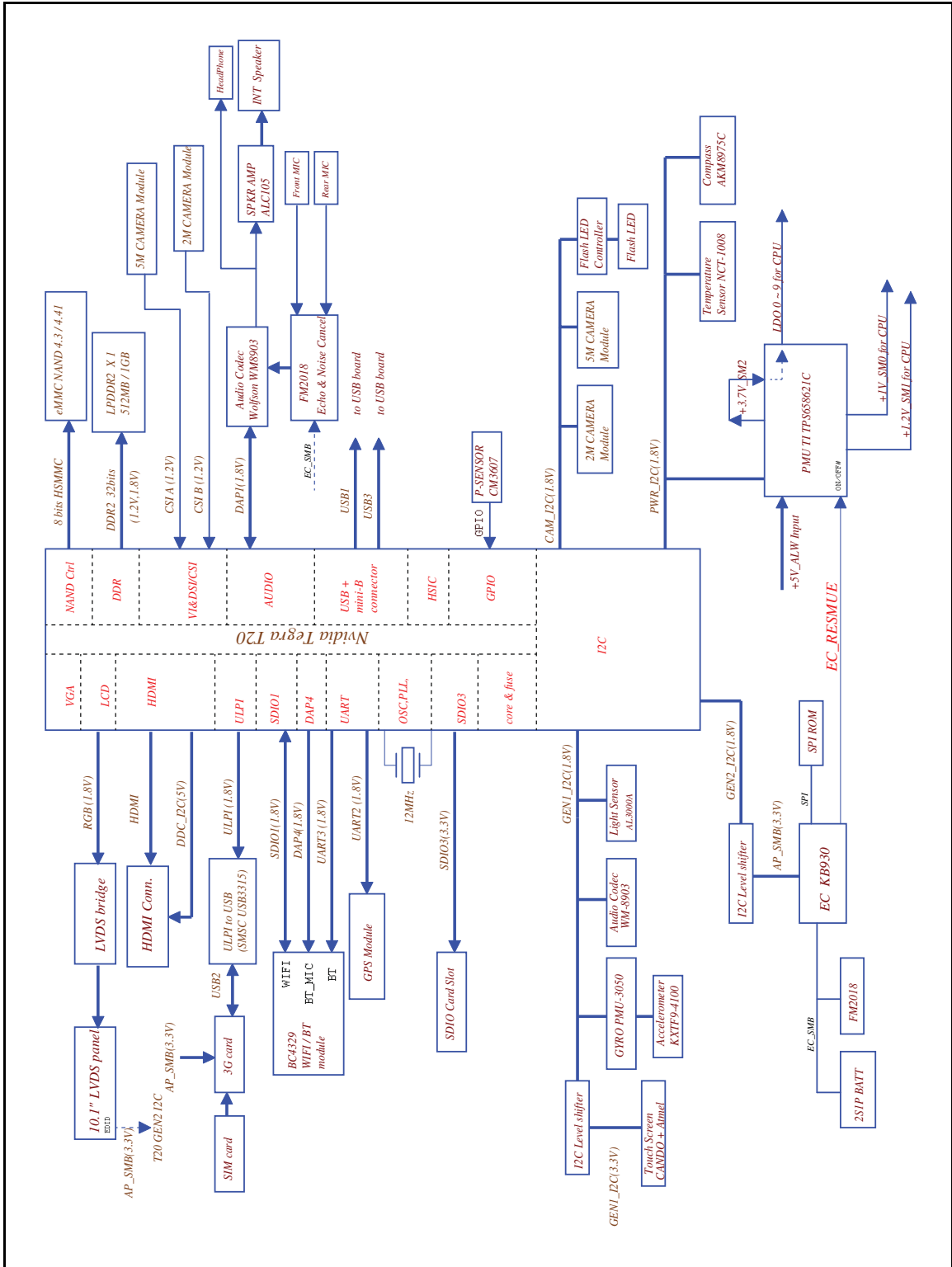


Figure 1-7. System Block Diagram

# Specification Tables

## Computer specifications

Item	Metric	Imperial
Dimensions		
Length	260mm	10.23in
Width	179mm	6.97in
Height (front to rear)	14mm	0.53in
Weight (equipped with optical drive, flash drive, and battery)	<ul style="list-style-type: none"> <li>• 740g (WiFi)</li> <li>• 750g (3G)</li> </ul>	<ul style="list-style-type: none"> <li>• 1.63lb (WiFi)</li> <li>• 1.65lb (3G)</li> </ul>
Weight (equipped with optical drive, flash drive, and without battery)	Build-in battery	Build-in battery
Input power		
Operating voltage	12.0 V dc @ 1.5 A - 18 W	
Operating current	1.5 A	
Temperature		
Operating (not writing to optical disc)	0°C to 50°C	32°F to 122°F
Operating (writing to optical disc)	0°C to 50°C	32°F to 122°F
Nonoperating	-20°C to 60°C	-4°F to 140°F
Relative humidity		
Operating	10% to 90%	
Nonoperating	5% to 95%	
Maximum altitude (unpressurized)		
Operating	-15 m to 3,048 m	-50 ft to 10,000 ft
Nonoperating	-15 m to 12,192 m	-50 ft to 40,000 ft
Shock		
Operating	125 g, 2 ms, half-sine	
Nonoperating	200 g, 2 ms, half-sine	
Random vibration		
Operating	0.75 g zero-to-peak, 10 Hz to 500 Hz, 0.25 oct/min sweep rate	
Nonoperating	1.50 g zero-to-peak, 10 Hz to 500 Hz, 0.25 oct/min sweep rate	
<b>⇒ NOTE:</b> Applicable product safety standards specify thermal limits for plastic surfaces. The computer operates well within this range of temperatures.		

## System Board Major Chips

Item	Specification
Core logic	Tegra 250 Dual cortex A9, 1GHz
Graphics	Integrated in Tegra 250 CPU (ULP GeForce)
LAN	N/A
USB 2.0	Integrated in Tegra 250 CPU (ULP GeForce)
Super I/O controller	N/A
Bluetooth	Broadcom BCM4329
Wireless	Broadcom BCM4329
PCMCIA	N/A
Audio codec	Wolfson WM8903
Card reader	SD 2.0 Integrated in Tegra 250 CPU
LVDS transmitter	SN75LVDS83B
PMU	TI TPS658621C
LDDR2	Elpida EDB8132B2PB 1GB
ULPI Phy for USB	SMSC USB3315
GPS	Broadcom BCM4751
TOUCH controller	Atmel ATMXT 1386-CHIPSET1PJA101
eMMC	Hynix H26M32001DAR
CAMERA	<ul style="list-style-type: none"> <li>• Omnivison OV5650: 5M</li> <li>• Various CSI: 2M</li> </ul>
Thermal Sensor	Onsemi NTC1008
Battery Charger	TI BQ24617
Compass	Asahi Kasei AKM8975C
Gyro	Invensense MPU-3050
ALS/Proximity	Lite On AL3000A / AZOTEK IQS128

## Processor

Item	Specification
CPU type	Dual-core ARM® Coretex-A9 MPcore Processor
CPU package	23 x 23 FCBGA
Core Logic	Integrated in Tegra 250 CPU
Chipset	Integrated in Tegra 250 CPU

## Processor Specifications

Item	CPU Speed (GHz)	Cores/Threads	Bus Speed (FSB/DMI/QBI)	Mfg Tech (nm)	Cache Size	Package	Voltage
T20	1	2 Cores		40		23x23 FCBGA	1.0-1.2V

## CPU Fan True Value Table (N/A)

CPU Temperature	Fan Speed (RPM)	SPL Spec (dBA)
60		
70		
80		
90		
100		

## System Memory

Item	Specification
Memory controller	Build in CPU
Memory size	1G LPDDRII
DIMM socket number	N/A. On board memory
Supports memory size per socket	N/A
Supports maximum memory size	On board LP-DDR2 1GB
Supports DIMM type	N/A
Supports DIMM Speed	N/A
Support DIMM voltage	N/A
Supports DIMM package	N/A



**BIOS (N/A)**

Item	Specification
BIOS vendor	
BIOS Version	
BIOS ROM type	
BIOS ROM size	
Features	

**LAN Interface (N/A)**

Item	Specification
LAN Chipset	
LAN connector type	
LAN connector location	
Features	

**Keyboard (N/A)**

Item	Specification
Type	
Total number of keypads	
Windows logo key	
Internal & external keyboard work simultaneously	
Features	

**Hard Disk Drive (AVL components) (N/A)**

Item	Specification			
Vendor & Model Name				
Capacity (GB)				
Bytes per sector				
Data heads				
<b>Drive Format</b>				
Disks				
Spindle speed (RPM)				
<b>Performance Specifications</b>				
Buffer size				
Interface				
Fast data transfer rate (Mbits / sec, max)				
Media data transfer rate (Mbytes/sec max)				
<b>DC Power Requirements</b>				
Voltage tolerance				
<b>⇒ NOTE:</b>				

### Embedded MultiMediaCard (AVL components)

Item	Specification			
Vendor & Model Name	Sandisk SDIN4C2-16G	Samsung KL MAG4EEHM	Sandisk SDIN4E2-32G	Samsung KLMBG8FEJA
Capacity (GB)	16G	16G	32G	32G
DC Power Requirements				
Voltage tolerance	1.8V			

### Super-Multi Drive (N/A)

Item	Specification	
Vendor & Model name		
Performance Specification		
Transfer rate (KB/sec)		
Buffer Memory		
Interface		
Applicable disc format		
Loading mechanism		
Power Requirement		
Input Voltage		

### BD Drive (N/A)

Items	Specifications		
Vendor & Model name			
Performance Specification			
Transfer rate (KB/sec)			
Buffer Memory			
Interface			
Applicable disc format			
Loading mechanism			
Power Requirement			
Input Voltage			



## LED 10.1”

Item	Specification
Vendor/Model name	AUO/B101EW05 V1
Screen Diagonal (mm)	255.85 mm
Active Area (mm)	216.96 mm x 135.6 mm
Display resolution (pixels)	1280 x 3(RGB) x 800
Pixel Pitch (mm)	0.1695mm x 0.1695mm
Typical White Luminance (cd/m <sup>2</sup> ) also called Brightness	300 cd/m <sup>2</sup>
Contrast Ratio	1000 min / 1300 type
Response Time (Optical Rise Time/Fall Time) msec	25 ms / 35 ms
Typical Power Consumption (watt)	3.4 W
Weight (without inverter)	180 max
Physical Size (mm)	229.46 mm x 149.1mm x 5.2 max
Electrical Interface	1 channel LVDS
Viewing Angle (degree) Horizontal (Right) CR = 10 (Left) Vertical (Upper) CR = 10 (Lower)	85 (Right) / 85 (Left) / 85 (Upper) / 85 (Lower) Typ.

## LCD Inverter (N/A)

Item	Specification
Vendor & Model name	
Brightness conditions	
Input voltage (v)	
Input current (mA)	
Output voltage (V, RMS)	
Output current (mA, RMS)	
Output voltage frequency (KHz)	

### Display Supported Resolution (LCD)

Resolution	16 bits	32 bits	36 bits	48 bits	others
1280x 3(RGB) x 800	X	X	X	V	X
Legend: V = Supported; X = Not supported					
<b>⇒ NOTE:</b> Resolution fixed at 1280 x 800. Not adjustable by end user.					

### Graphics Controller

Item	Specification
VGA Chip	ULP GeForce
Supports	<ul style="list-style-type: none"><li>• Fully Programmable Yes</li><li>• OpenGL ES Version 2</li><li>• OpenVG 1.1</li><li>• EGL 1.4</li></ul>

### Display Supported Resolution (GPU)

Resolution	16 bits	32 bits	36 bits	48 bits	others
1280x 3(RGB) x 800	X	X	X	V	X
Legend: V = Supported; X = Not supported					
<b>⇒ NOTE:</b> Resolution fixed at 1280 x 800. Not adjustable by end user.					

### Bluetooth Interface

Item	Specifications
Chipset	Azurewave AW-NH611- Broadcom 4329 SIP
Data throughput	<ul style="list-style-type: none"><li>• TX 1.2Mbps/sec</li><li>• RX 1.2Mbps/sec</li></ul>
Protocol	2.1 + EDR 3.0 upgradable
Interface	SIP
Connector type	SIP
Supported protocol	(Add BT supported protocol here such as A2DP)

### Bluetooth Module

Item	Specifications
Controller	Azurewave AW-NH611 - Broadcom BCM4329 SoC
Features	<ul style="list-style-type: none"><li>• Fully support BT 2.1 +EDR</li><li>• UART Interface</li></ul>

### Front Camera

Item	Specification
Vendor and Model	Chicony / Aptina 2031
Type	2M

### Rear Camera

Item	Specification
Vendor and Model	<ul style="list-style-type: none"><li>• Liteon / OV5650 CSI</li><li>• Liteon / Aptina 5140</li></ul>
Type	5M

### Mini Card

Item	Specification
Number supported	1
Features	1 mini card slot (for WWAN)

### 3G Card

Item	Specification
Features	3G Module with Ericsson 5521gw

## Audio Codec and Amplifier

Item	Specification
Audio Controller	Wolfson WM8903
Features	<ul style="list-style-type: none"> <li>• 4.5mW Power consumption for DAC to headphone playback</li> <li>• DAC SNR 96dB typical, THD -86dB typical</li> <li>• ADC SNR 92dB typical, THD -80dB typical</li> <li>• Control sequencer for pop minimized start-up and shut-down</li> <li>• Single register write for default start-up sequence</li> <li>• Stereo digital microphone input</li> <li>• 3 single ended inputs per stereo channel</li> <li>• 2 pseudo differential inputs per stereo channel</li> <li>• 1 fully differential mic inputs per stereo channel</li> <li>• Digital Dynamic Range Controller</li> <li>• Digital sidetone mixing</li> <li>• Ground-referenced headphone driver</li> <li>• Ground-referenced line input</li> <li>• Stereo differential line driver for direct interface to WM9001 speaker driver</li> <li>• 40-pin5x5mm QFN package</li> </ul>
Amplifier	N/A
Features	N/A

## Audio Interface

Item	Specification
Audio Controller	Wolfson WM8903
Audio onboard or optional	On board
Mono or Stereo	Stereo
Resolution	Support 24bit
Compatibility	I2S audio Interface
Sampling rate	Sample rate up to 44.1KHz
Internal microphone	Yes
Internal speaker/quantity	Yes/(1W speakers x2)

## Wireless Module 802.11b/g/n

Item	Specification
Chipset	Azurewave AW-NH611 - Broadcom BCM4329 SoC
Data throughput	<ul style="list-style-type: none"><li>• 802.11b/g: 11~54 Mbps</li><li>• 802.11n: MCS 0-7</li></ul>
Protocol	IEEE 802.11b/g/n
Interface	SDIO/SPI interface.

## Battery

Item	Specification
Vendor & Model name	SIMPLO BAT-1010   SANYO BAT100
Battery Type	Li-ion
Pack capacity	3260mAh/24Wh
Number of battery cell	2
Package configuration	2S1P

## VRAM

Item	Specification
Chipset	T20 UMA architecture
Memory size	Share 16 ~ 256MB
Interface	LPDDR2

## USB Port

Item	Specification
USB compliance level	USB2.0
Protocol	EHCI
Number of USB port(s)	2
Location	two at the right side
Output Current	1.5A (for USB host port)

## HDMI Port

Item	Specification
Compliance level	HDMI1.3a
Data throughput	Up to 16.7 million colors
Number of HDMI port(s)	1
Location	JHDMI1 at the left side

## AC Adapter

Item	Specification
Input rating	18W
Maximum input AC current	0.5A(RMS) at 100Vac
Inrush current	60A Max. @230Vac
Efficiency	Refer to EPS 2.0 standard level V

## System Power Management

Item	Specification
Mech. Off (G3)	Only EC working.
Soft Off (G2/S5)	Only EC working.
Working (G0/S0)	Individual devices such as the CPU and eMMC may be power managed in this state.
Suspend to RAM (S3)	<ul style="list-style-type: none"><li>• CPU suspend</li><li>• Audio Power Down</li><li>• eMMC Power Down</li><li>• LCD power off</li><li>• MIC power off</li></ul>
Save to Disk (S4)	N/A

## Card Reader

Item	Specification
Chipset	Embedded in T20 SOC.
Package	FCBGA -664 23X23
Maximum supported size	SD: 32G
Features	Storage cards with adapter: micro SD™

## System LED Indicator

Item	Specification
Lock	
System state	<ul style="list-style-type: none"><li>• White color: Flash on booting</li><li>• White color and amber color off: System off / suspend</li><li>• Amber color: Battery in charging</li></ul>
HDD access state	N/A
Wireless state	N/A
Power button backlight	Same as system state
Battery state	Same as system state

## System DMA Specification

Legacy Mode	Power Management
DMA0	Not applicable
DMA1	Not applicable
DMA2	Not applicable
DMA3	Not applicable
DMA4	Direct memory access controller
DMA5	Available for ExpressCard
DMA6	Not Assigned
DMA7	Not Assigned
*ExpressCard controller can use DMA 1, 2, or 5.	

## System Interrupt Specification (N/A)

Hardware IRQ	System Function
IRQ0	
IRQ1	
IRQ2	
IRQ3	
IRQ5*	
IRQ6	
IRQ7*	
IRQ8	
IRQ9*	
IRQ10*	
IRQ11	
IRQ12	
IRQ13	
IRQ14	
IRQ15	
*Default configuration; audio possible configurations are IRQ5, IRQ7, IRQ9, IRQ10, or none.	
<b>⇒ NOTE:</b> ExpressCards may assert IRQ3, IRQ4, IRQ5, IRQ7, IRQ9, IRQ10, IRQ11, or IRQ15. Either the infrared or the serial port may assert IRQ3 or IRQ4.	

### System IO Address Map (N/A)

I/O address (hex)	System Function (shipping configuration)
000 - 00F	
010 - 01F	
020 - 021	
022 - 024	
025 - 03F	
02E - 02F	
040 - 05F	
044 - 05F	
060	
061	
062 - 063	
064	
065 - 06F	
070 - 071	
072 - 07F	
080 - 08F	
090 - 091	
092	
093 - 09F	
0A0 - 0A1	
0A2 - 0BF	
0C0 - 0DF	
0E0 - 0EF	
0F0 - 0F1	
0F2 - 0FF	
100 - 16F	
170 - 177	
178 - 1EF	
1F0 - 1F7	
1F8 - 200	
201	
202 - 21F	



## System I/O Address Specifications (N/A)

I/O address (hex)	System Function (shipping configuration)
220 - 22F	
230 - 26D	
26E - 26	
278 - 27F	
280 - 2AB	
2A0 - 2A7	
2A8 - 2E7	
2E8 - 2EF	
2F0 - 2F7	
2F8 - 2FF	
300 - 31F	
320 - 36F	
370 - 377	
378 - 37F	
380 - 387	
388 - 38B	
38C - 3AF	
3B0 - 3BB	
3BC - 3BF	
3C0 - 3DF	
3E0 - 3E1	
3E2 - 3E3	
3E8 - 3EF	
3F0 - 3F7	
3F8 - 3FF	
CF8 - CFB	
(PCIDIVO-1)	
(PCIDIVO-1)	



# CHAPTER 2

## Diagnostic Utilities

---

**Introduction . . . . .2-3**  
**NGA EUU Installation Procedure. . . . .2-3**  
**Picasso Diagnostic Tool . . . . .2-11**

## Introduction

---

The Gateway TP-A60W/ TP-A60G has a set of software tools designed to diagnose problems with its hardware components.

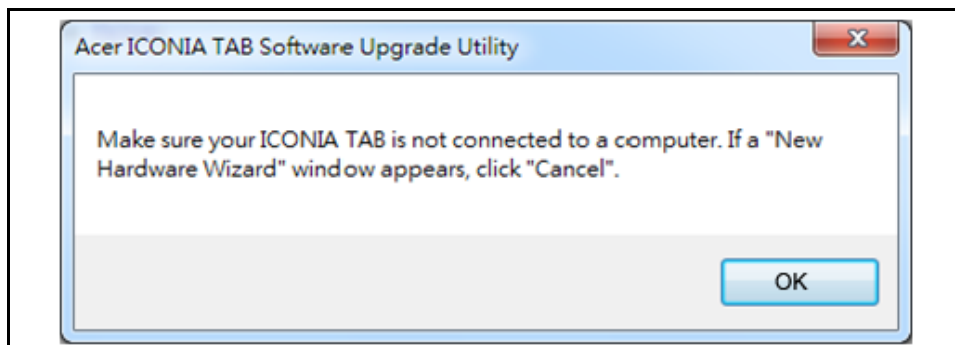
## NGA EEU Installation Procedure

---

⇒ **NOTE:**

Before installing EEU software, make sure the TP-A60W/ TP-A60G tablet is not connected to a computer.

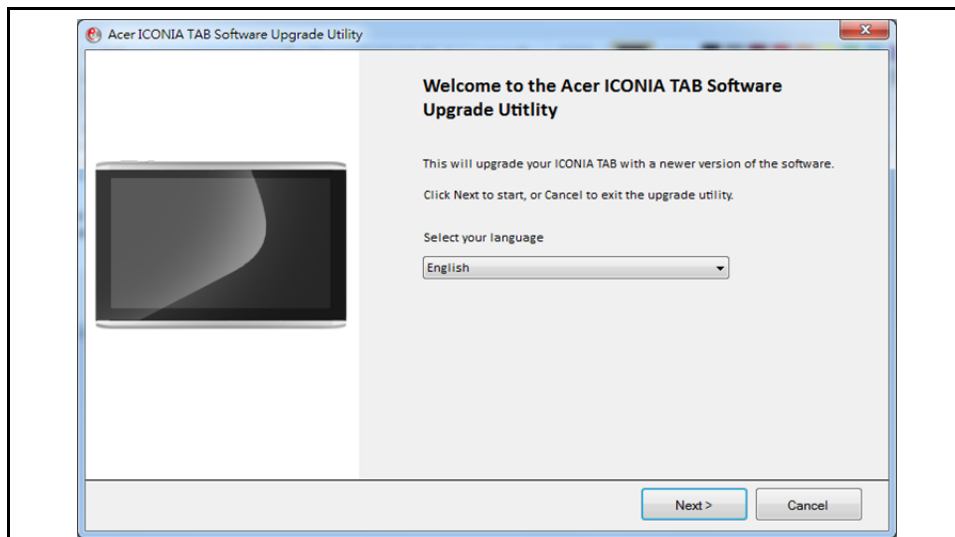
1. Install EEU software on a PC. When the following dialog is shown, click **OK** to continue.



---

**Figure 2-1. Starting Installation**

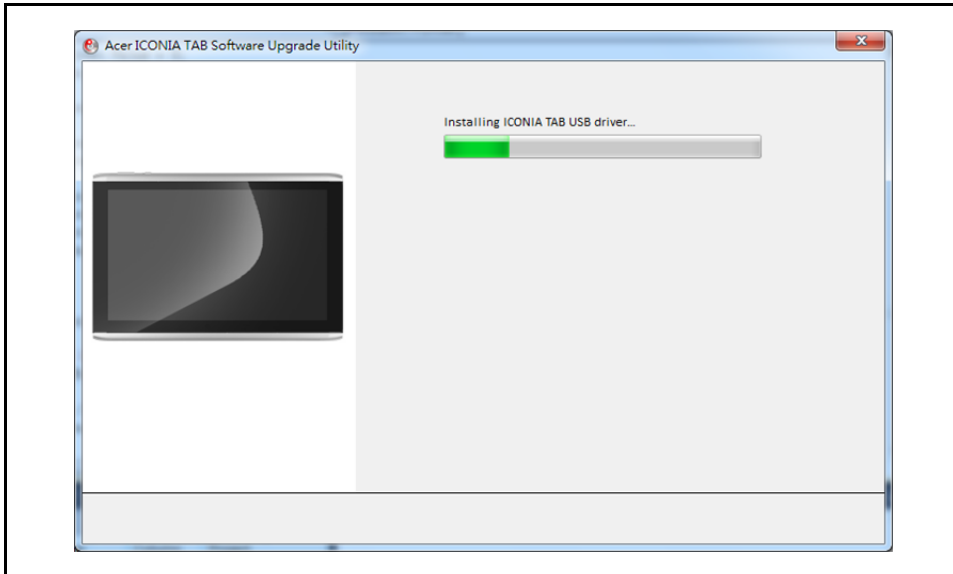
2. Select installation procedure language from drop-down list. Click **Next** to continue or **Cancel** to exit program.



---

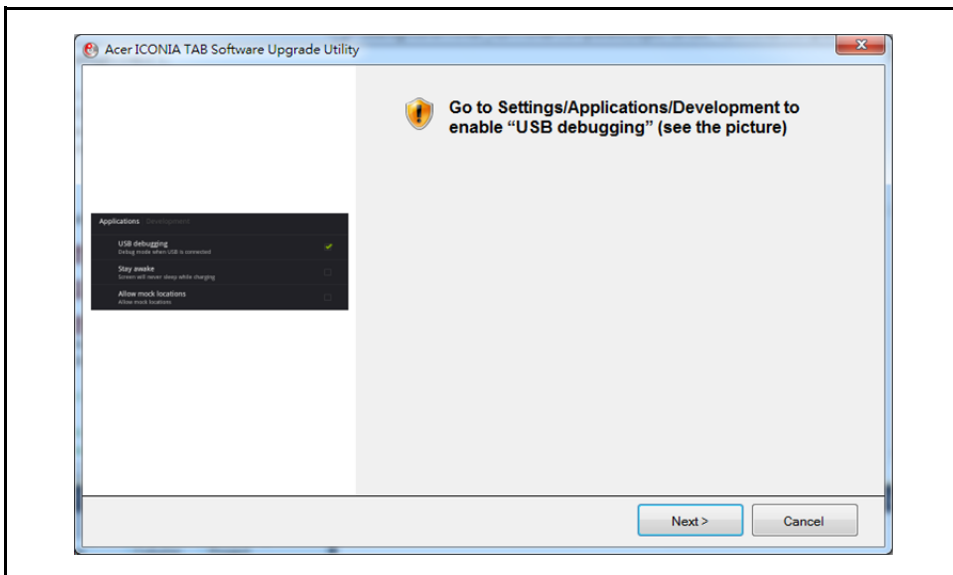
**Figure 2-2. Installation Procedure Language**

3. Install USB driver. (Figure 2-3)



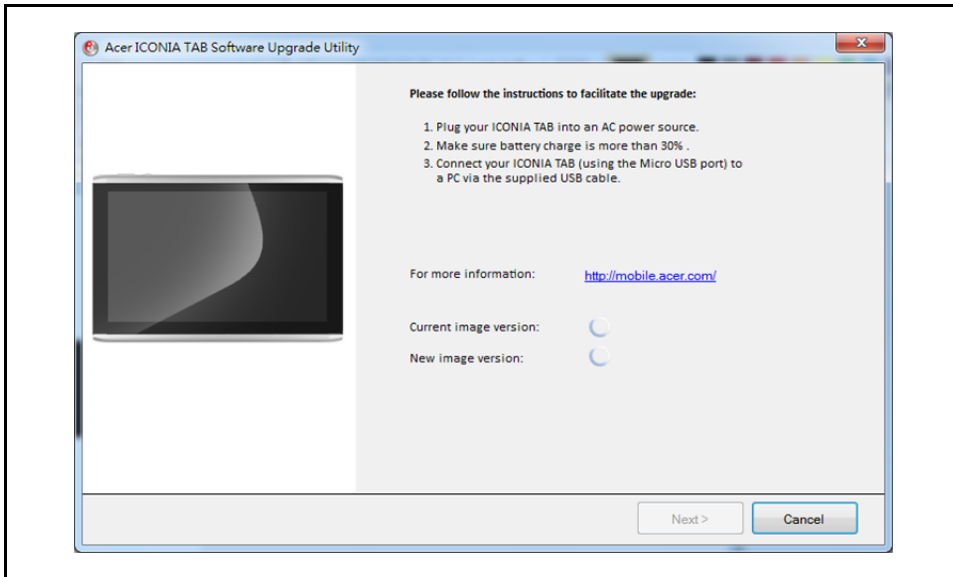
**Figure 2-3. USB Driver Installation**

4. To enable USB debugging, on the device, go to the Settings/Applications/Development menu and click the USB debugging checkbox. (Figure 2-4.)



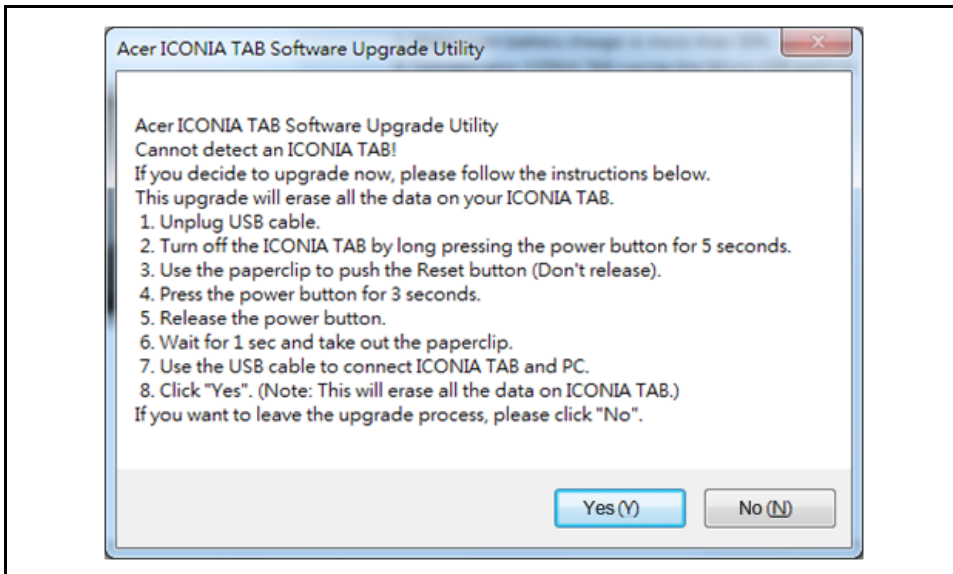
**Figure 2-4. USB Debugging**

5. Follow the instructions shown in Figure 2-5 to find OS image version.



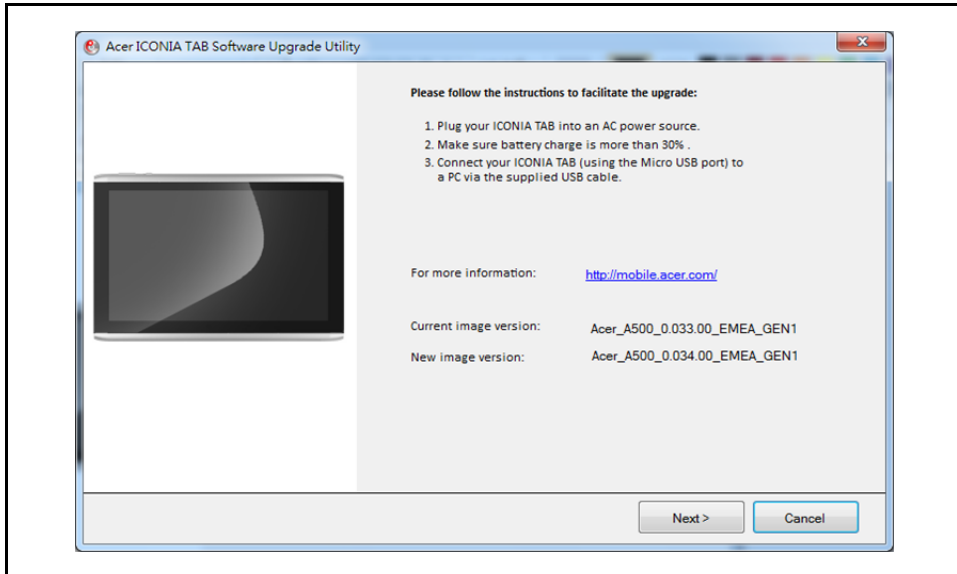
**Figure 2-5. Finding OS Image Version**

6. If image version is not available, follow instructions in Figure 2-6 to manually reset device. When procedure is complete, go to [Step 1](#) of this procedure.



**Figure 2-6. Device Reset Instructions**

7. If image version is available, current and new version information is shown. Click **Next** to continue. (Figure 2-7)

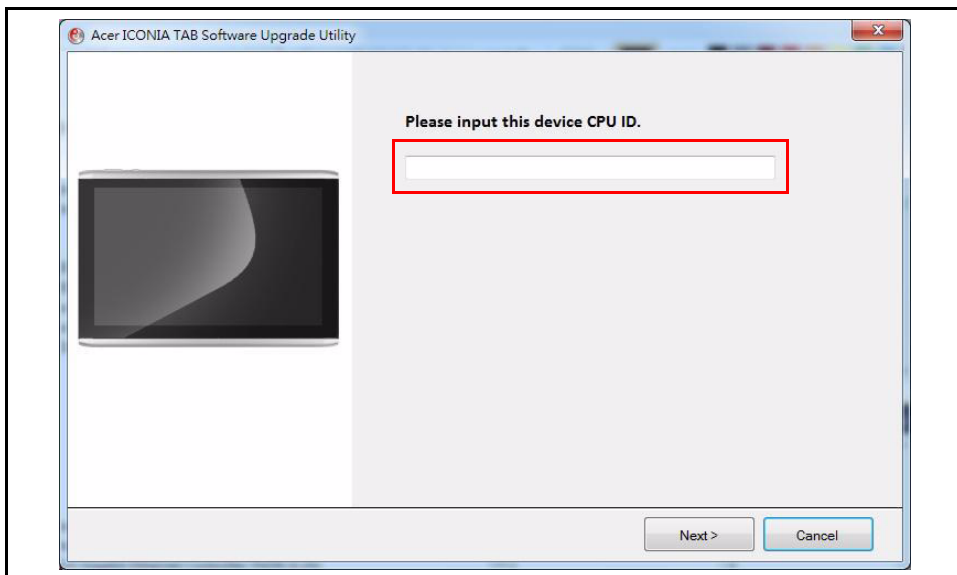


**Figure 2-7. Image Versions**

8. Enter CPU ID of device. Click **Next** to continue. (Figure 2-8)

⇒ **NOTE:**

Maximum number of characters for ID is sixteen (16).



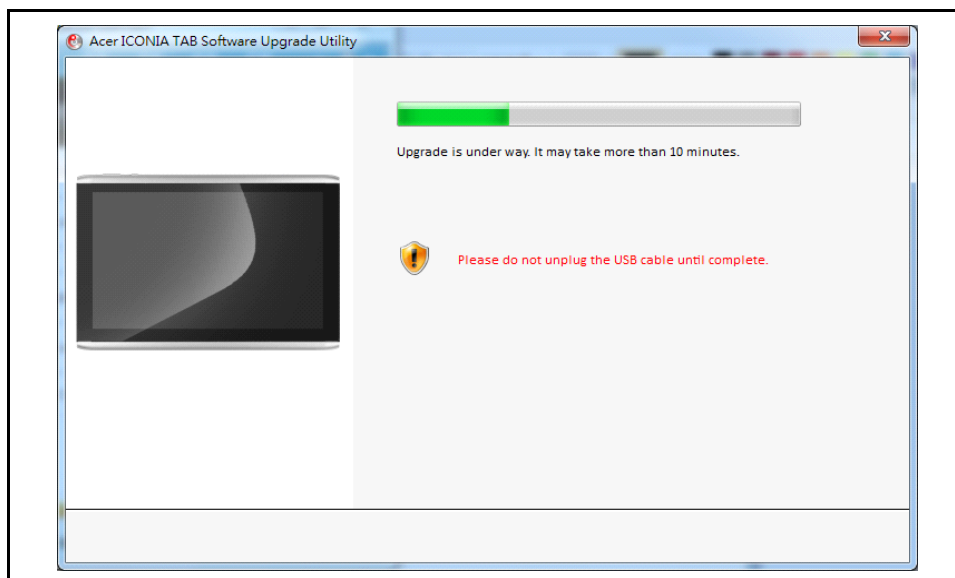
**Figure 2-8. CPU ID**



9. Upgrade process begins as shown in Figure 2-9

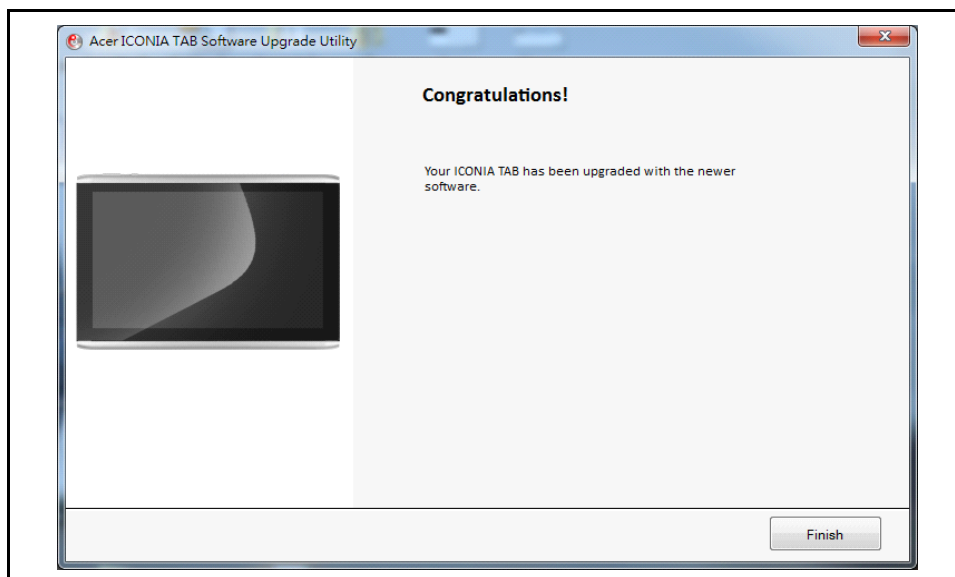
**+ IMPORTANT:**

Upgrade process will not complete if USB cable is unplugged.



**Figure 2-9. Upgrade Process**

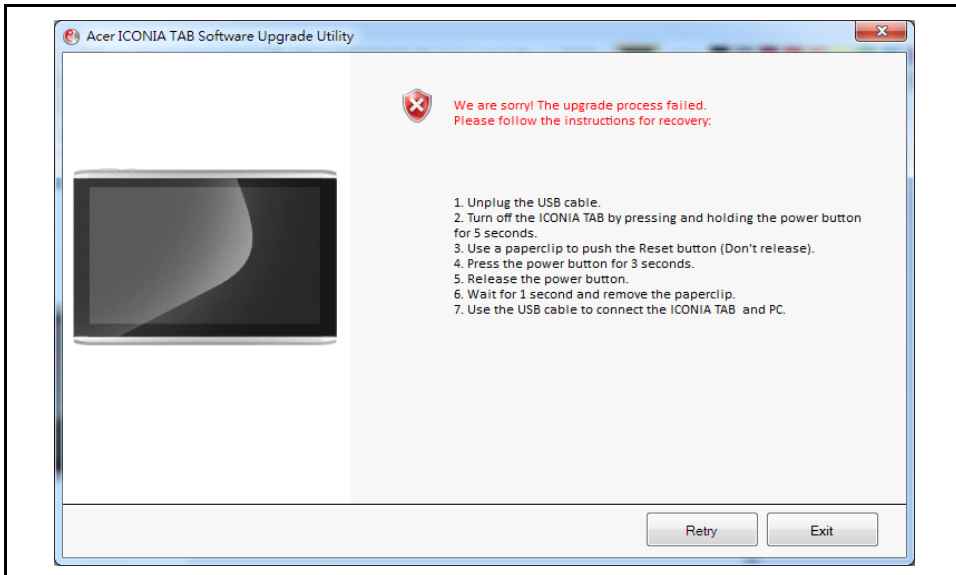
10. If upgrade process is successful, Figure 2-10 is shown. If an upgrade error is shown, go to step 12, if a CPU ID value error is identified, go to step 19.



**Figure 2-10. Upgrade Process Success**

11. Click **Finish** to exit.

12. If CPU ID is correct but upgrade process is not successful, Figure 2-11 is shown.

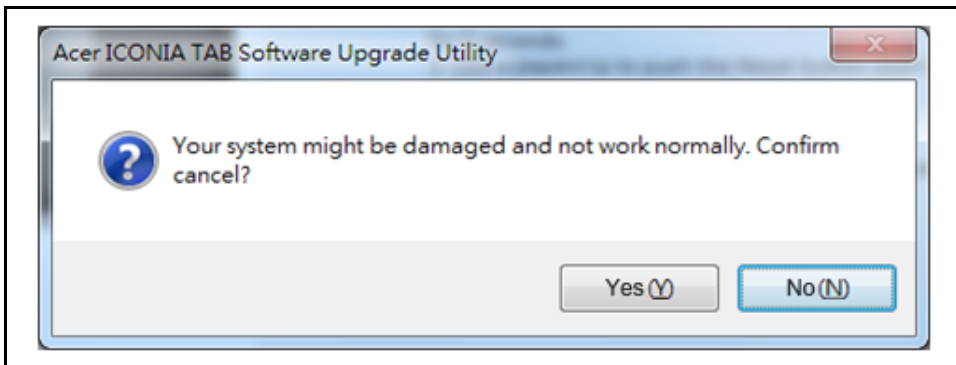


**Figure 2-11. Upgrade Process Failure**

13. Click **Retry** to start upgrade process. Go to [Step 8](#).

14. Click **Exit** to cancel upgrade process.

15. If upgrade process is cancelled, a confirmation dialog is shown. (Figure 2-12)

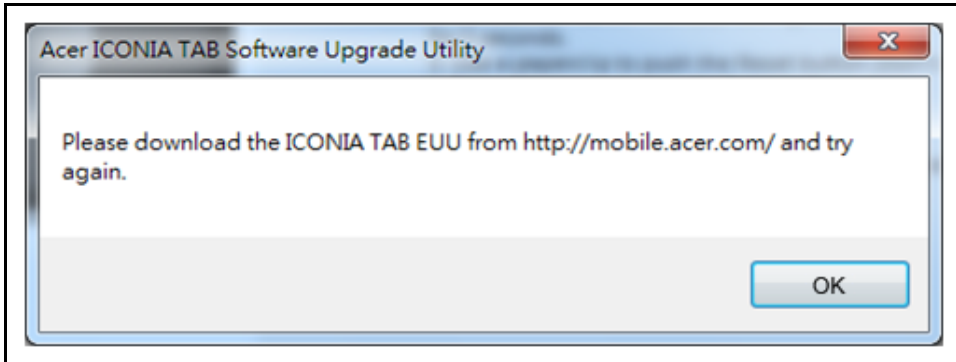


**Figure 2-12. Upgrade Process Cancellation Confirmation Dialog**

16. Click **No** to return to Retry dialog in Step 12.

17. Click **Yes** to confirm cancellation.

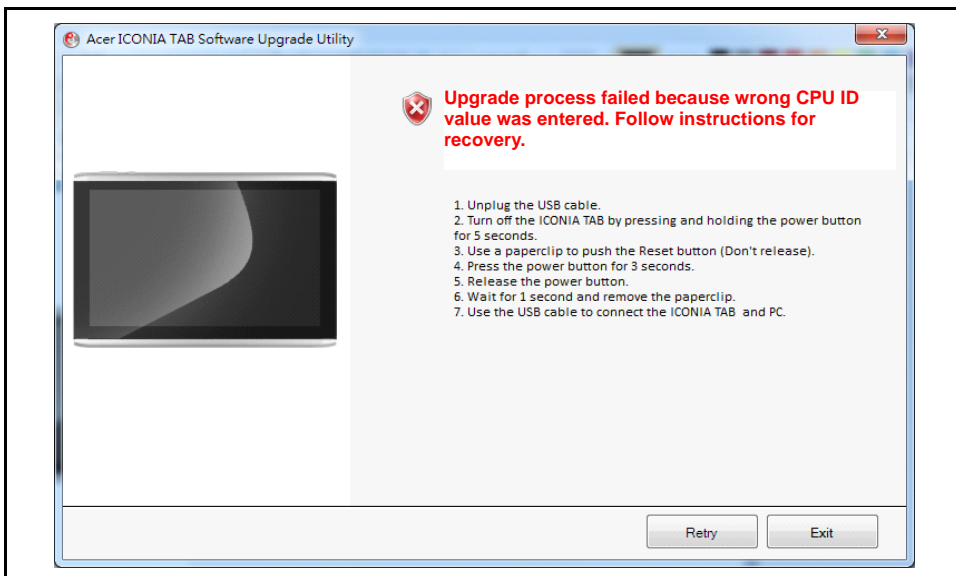
18. Click **OK** to exit the program. (Figure 2-13)



---

**Figure 2-13. Final Cancellation Dialog**

19. If CPU ID value is not correct, Figure 2-14 is shown.



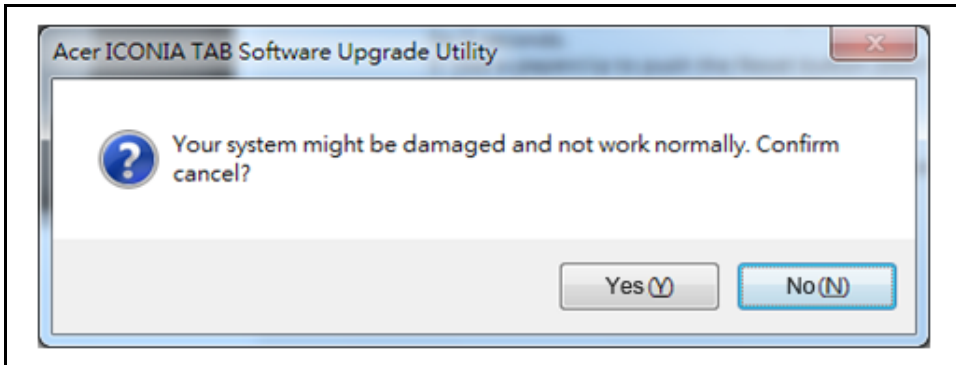
---

**Figure 2-14. Wrong CPU ID**

20. Click **Retry** to start upgrade process. Go to [Step 8](#).

21. Click **Exit** to cancel upgrade process.

22. If upgrade process is cancelled, a confirmation dialog is shown. (Figure 2-15)



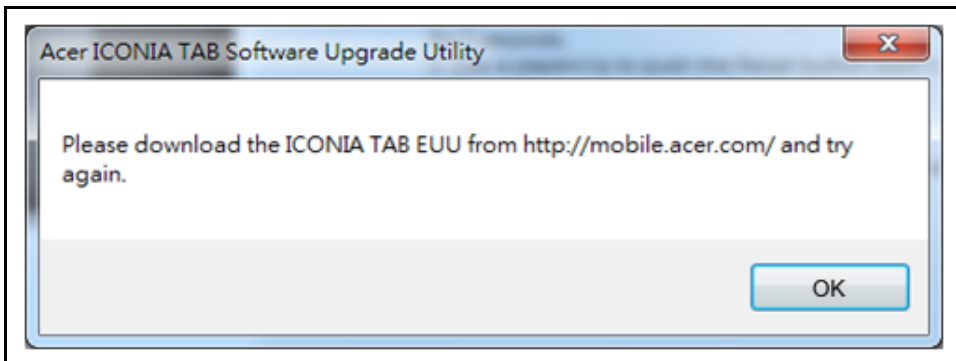
---

**Figure 2-15. Upgrade Process Cancellation Confirmation Dialog**

23. Click **No** to return to Retry dialog in Step 19.

24. Click **Yes** to confirm cancellation.

25. Click **OK** to exit program. (Figure 2-16)



---

**Figure 2-16. Final Cancellation Dialog**

# ICONIA tab A500

## Diagnostic Tool SOP

Release date : Apr. 14, 2011



# Preparation

Diagnostic tool - A500 Diagnostic Tool.zip

USB Driver of A500 for PC

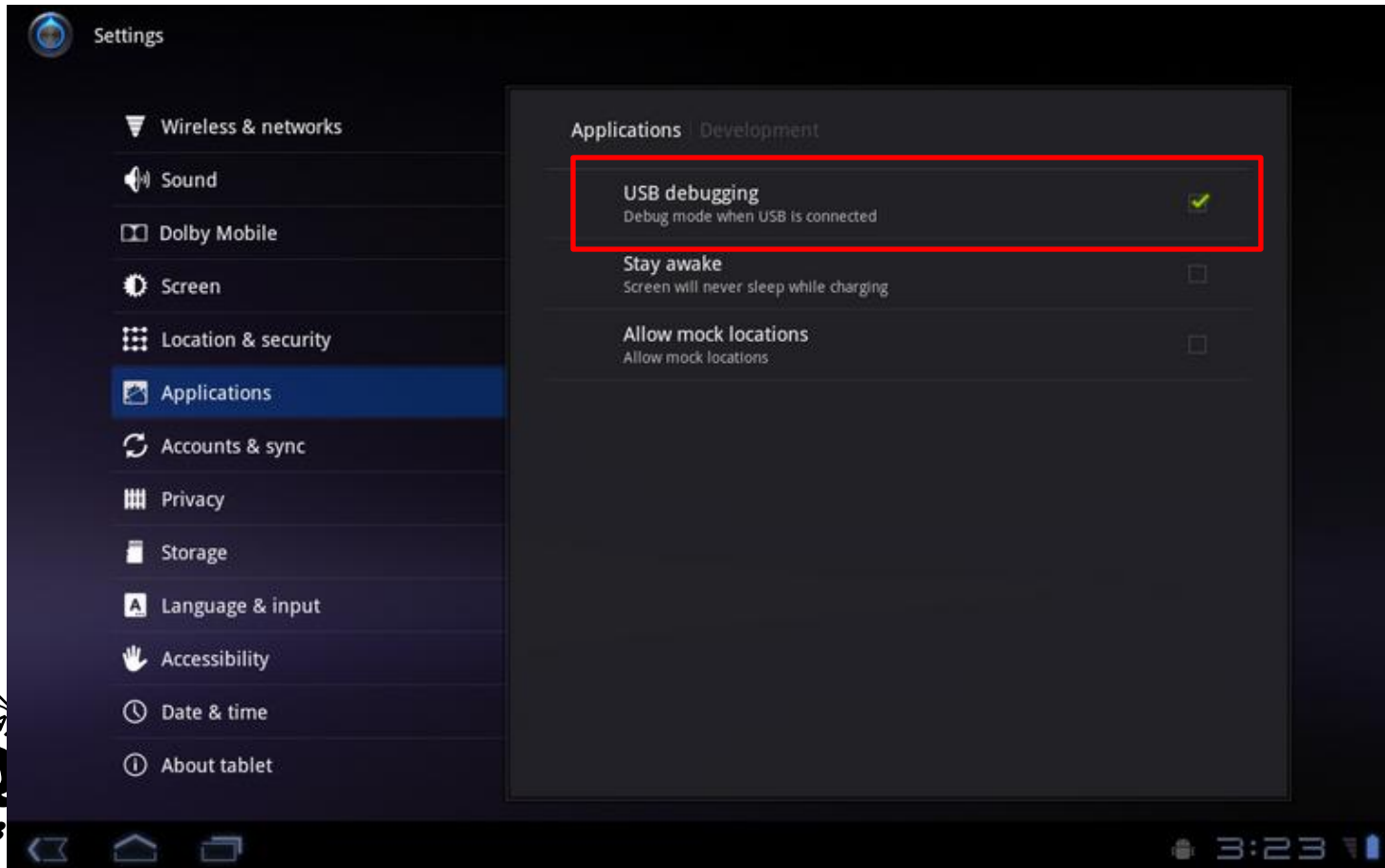
USB cable

Micro SD card



# Tool installation

1. Install USB driver in PC/NB.
2. Connect A500 device to PC/NB via USB cable
3. Enable “USB debugging” in A500 (Settings → Applications → USB debugging)

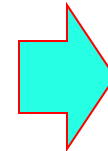
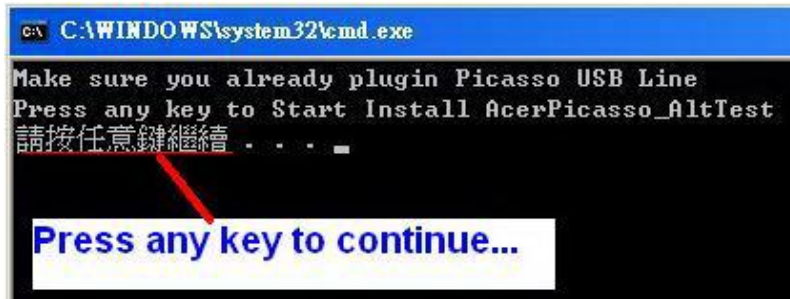


# Tool installation

4. Unzip file “A500 Diagnostic Tool.zip”. There are four files in the folder.



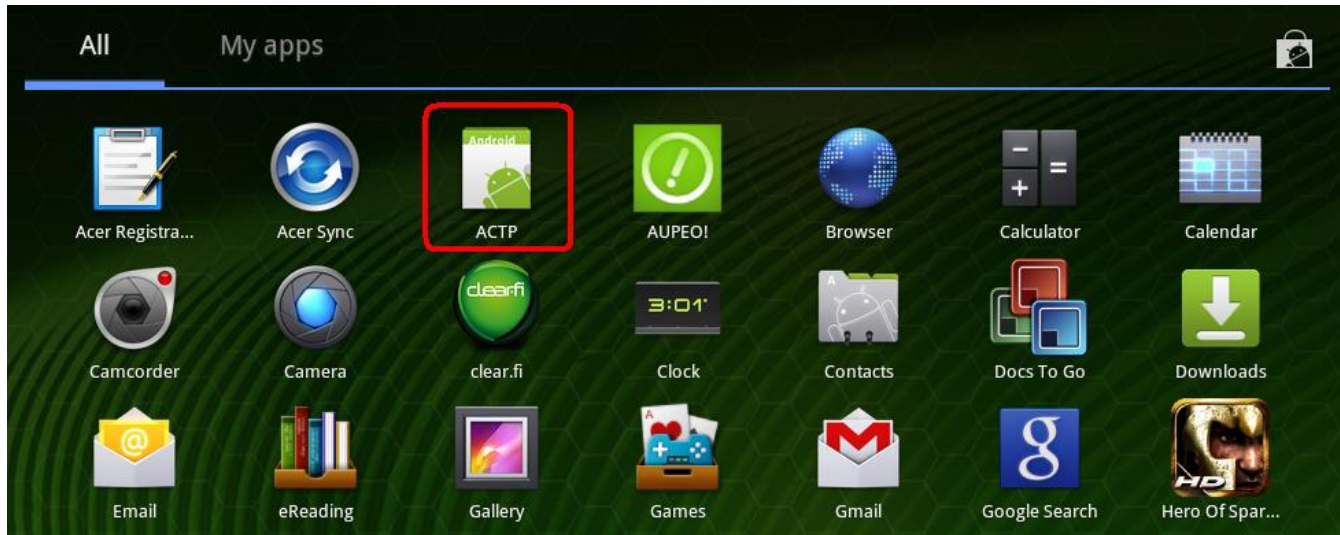
5. Run “Install\_A500\_DiagTool.bat”.





# Tool installation

6. On the “All” apps screen, look for the application called “ACTP”. This is the diagnostic tool.

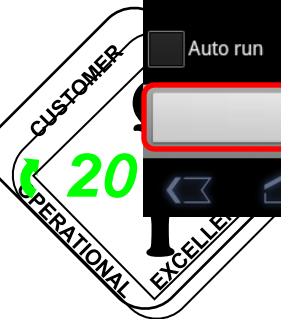
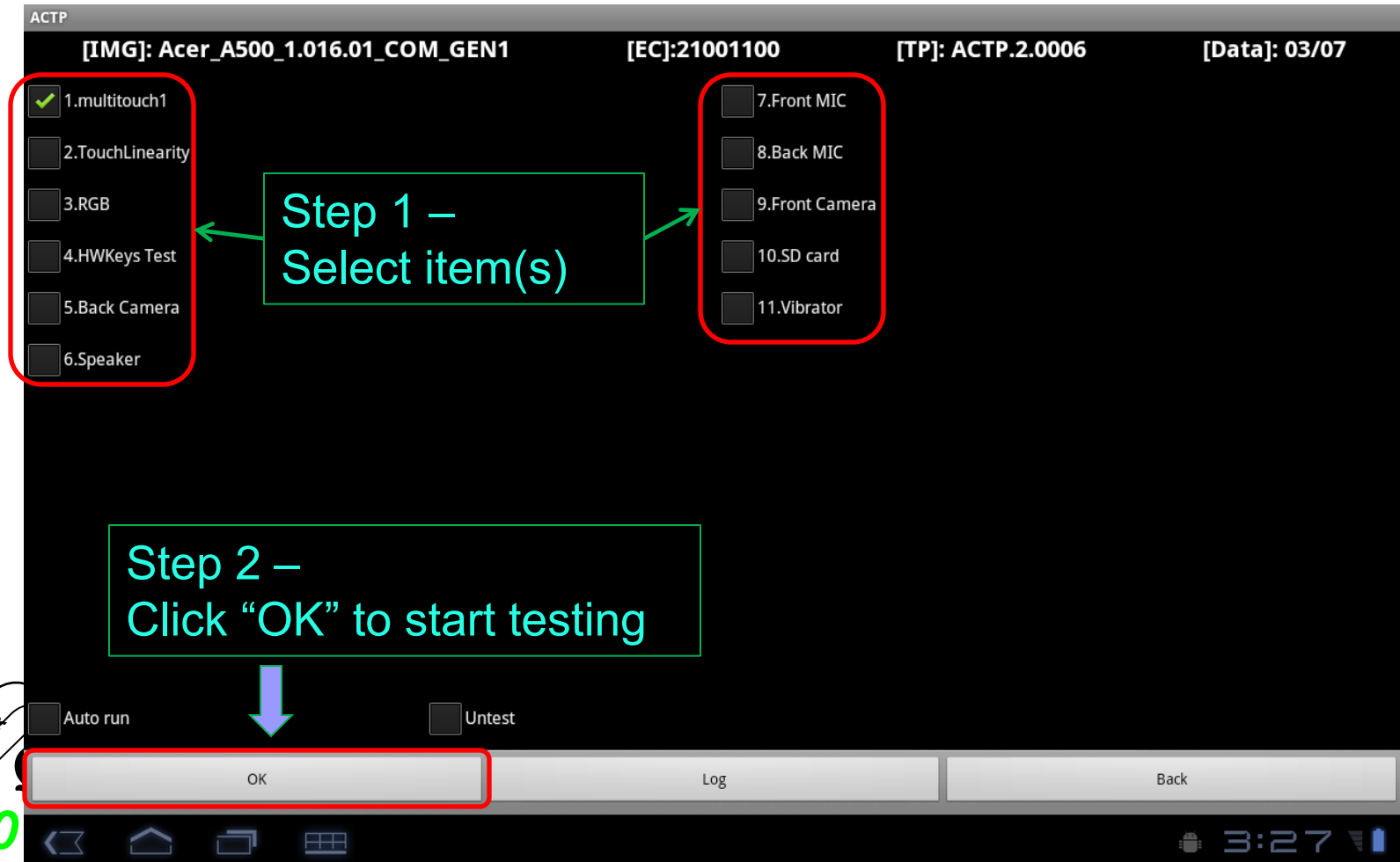


7. Tap the icon to start the testing process.



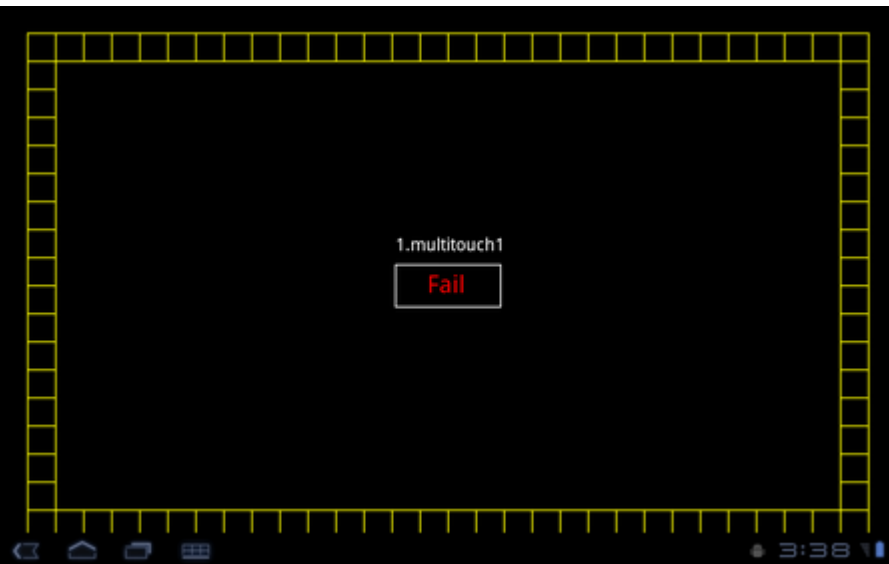
# Main Menu

The diagnostic tool tests the Touch Panel, Display, Buttons, Speaker, MIC, Camera, SD and Vibrator functionality. Select the function(s) you want to test. Tap “OK” to start.



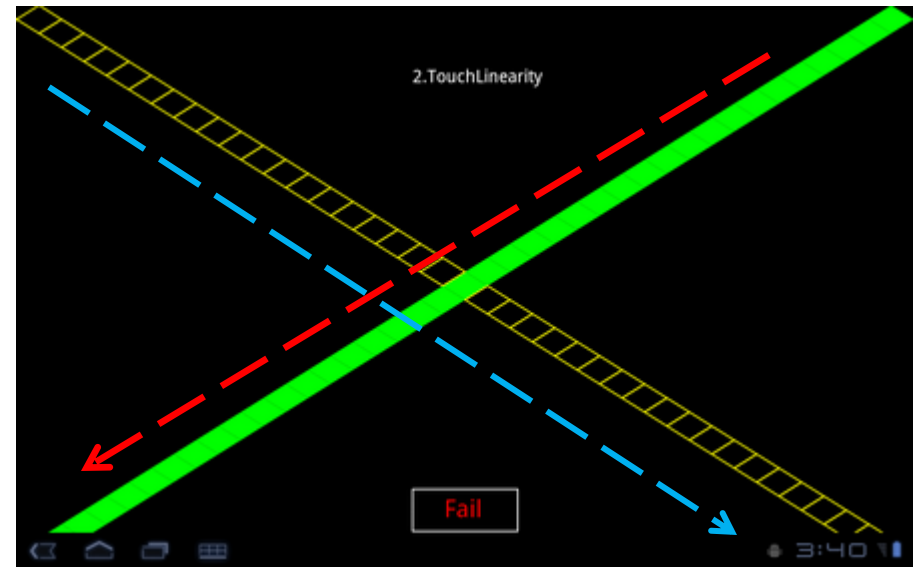
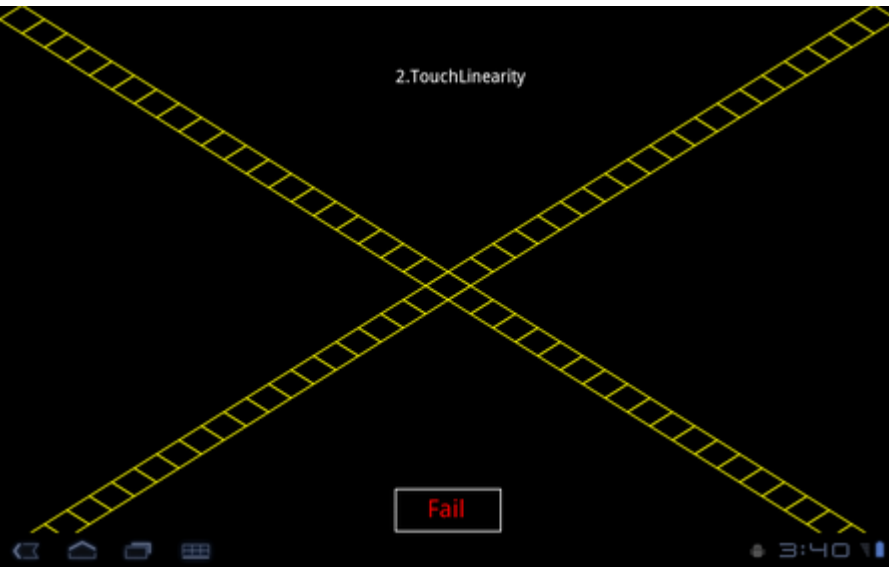
# 1. Multi-touch Test (Touch Panel)

Draw your finger along the yellow squares. The result is a pass if you fill all yellow squares and fail if you do not. The program returns to the main menu after the test is finished.



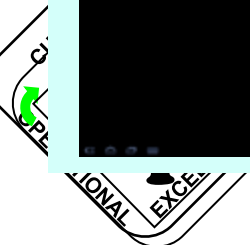
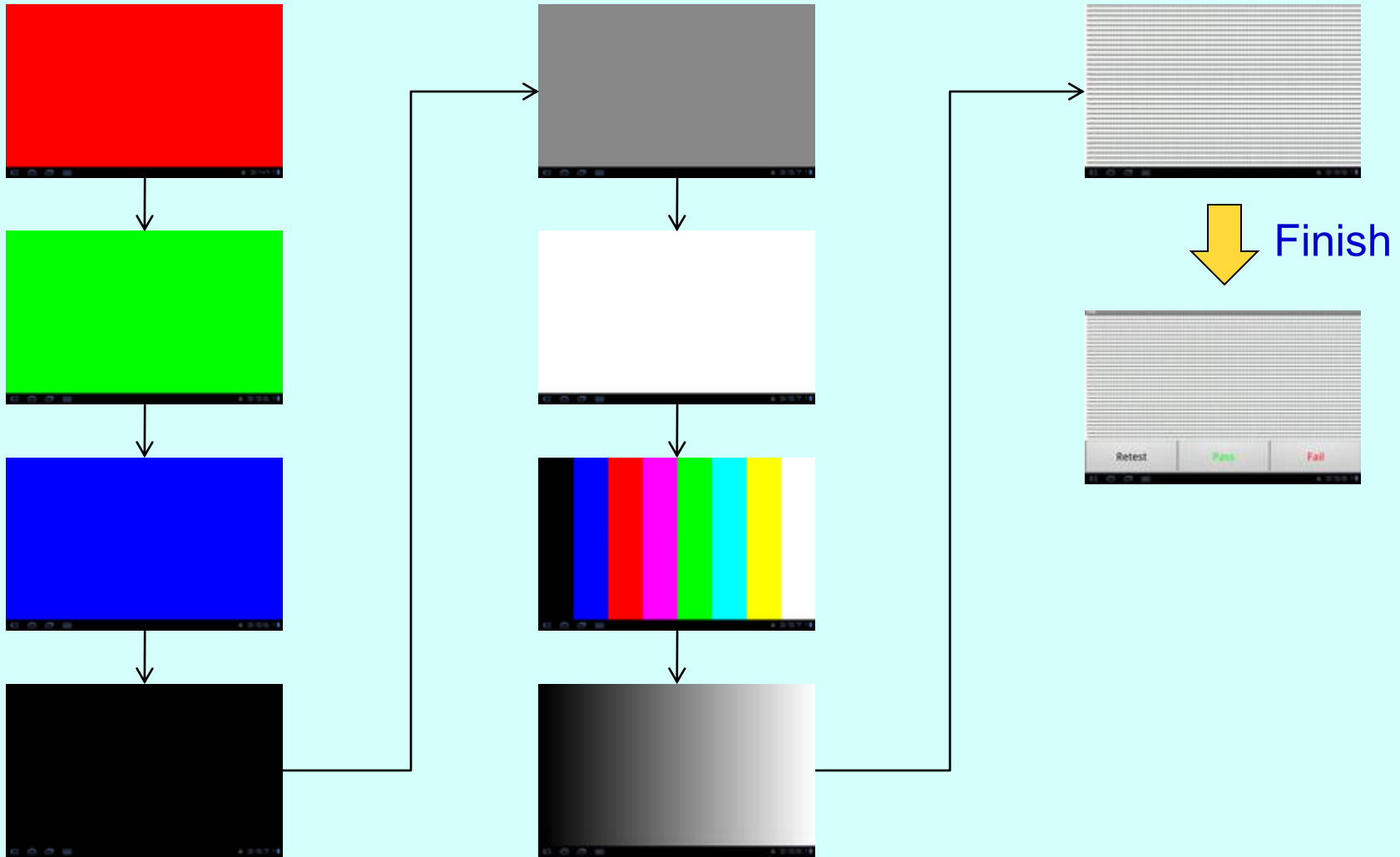
## 2. Touch Linearity Test (Touch Panel)

Draw your finger along the yellow squares. The result is a pass if you fill all yellow squares and fail if you do not. The program returns to the main menu after the test is finished.



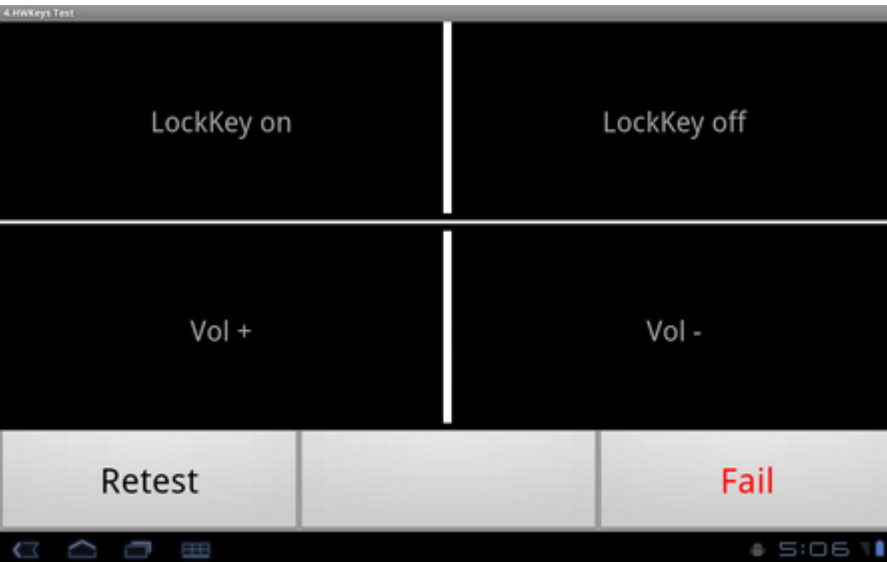
### 3. RGB (Display)

Continue to tap screen to display changes. Use this test to verify abnormal lines or dead pixels on LCD screen.



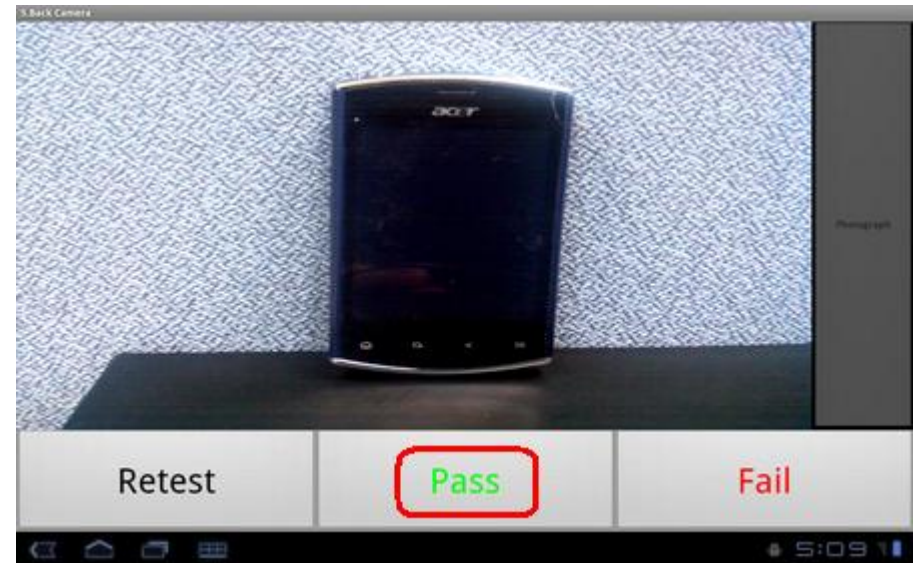
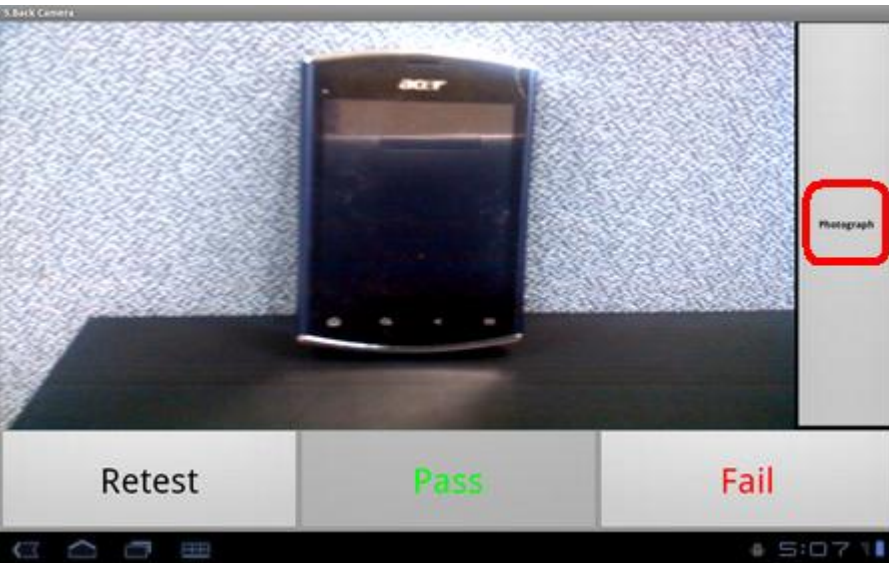
## 4. Hardware Keys Test (Keys)

Press volume up, volume down and lock keys to verify if all keys work. A color change to green means key function works.



## 5. Rear Camera

Point rear side of device at an object. Tap “Photograph” icon to test picture taking functionality.



# 6. Speaker

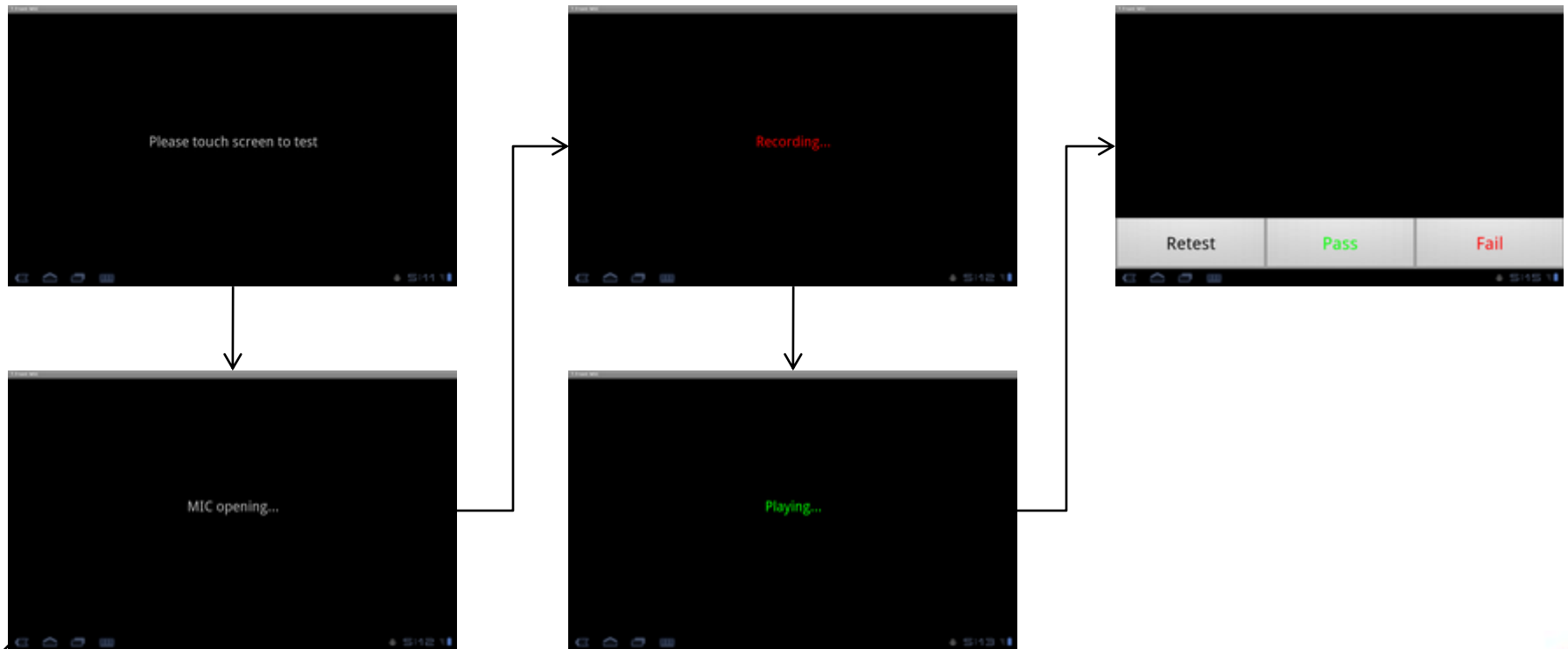
Loud tone sounds in left speaker then switches to right speaker.





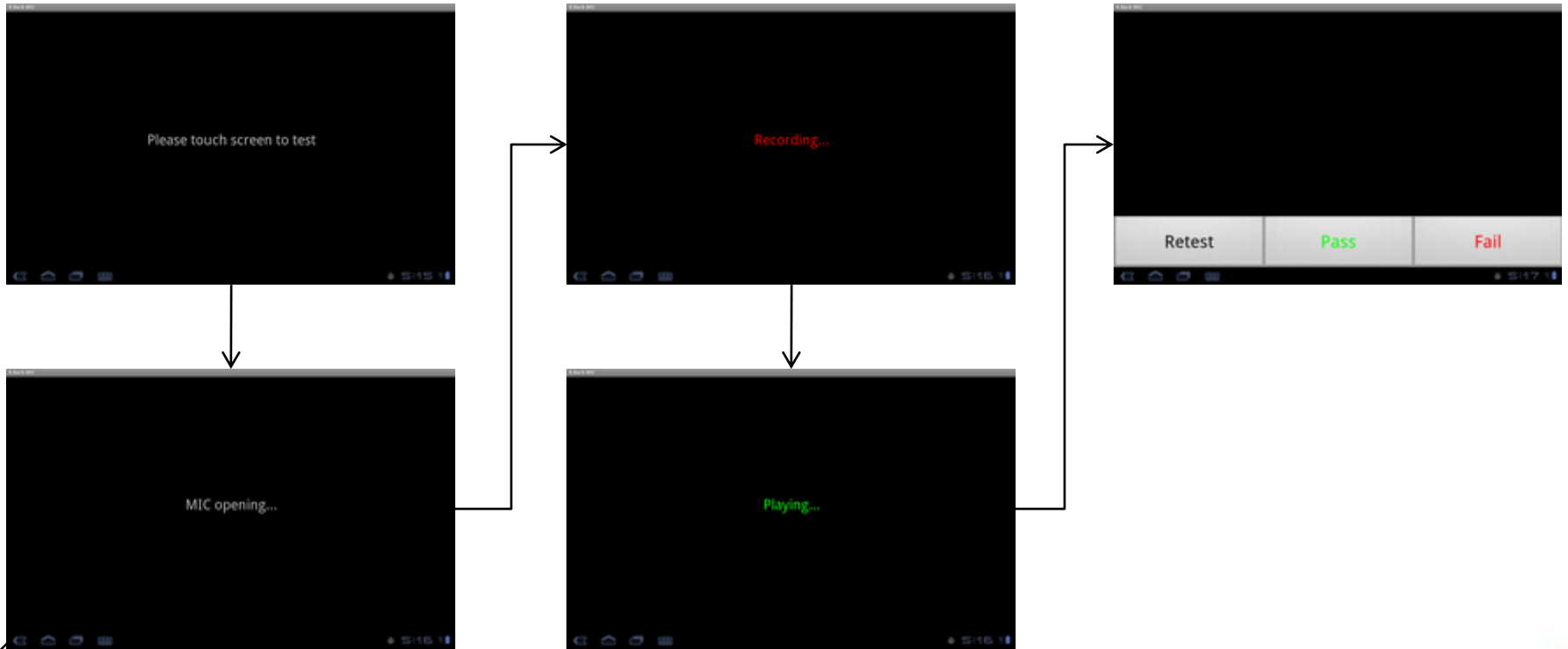
# 7. Front Microphone

Tap screen to start the test. When “Recording” screen appears, speak into front side of device. Check if voice recorded when screen switches to “Playing” screen.



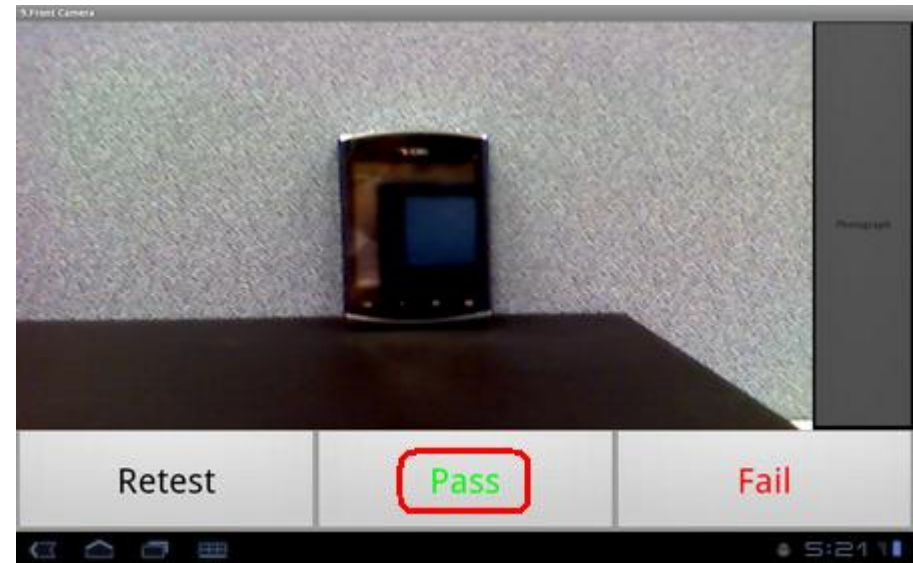
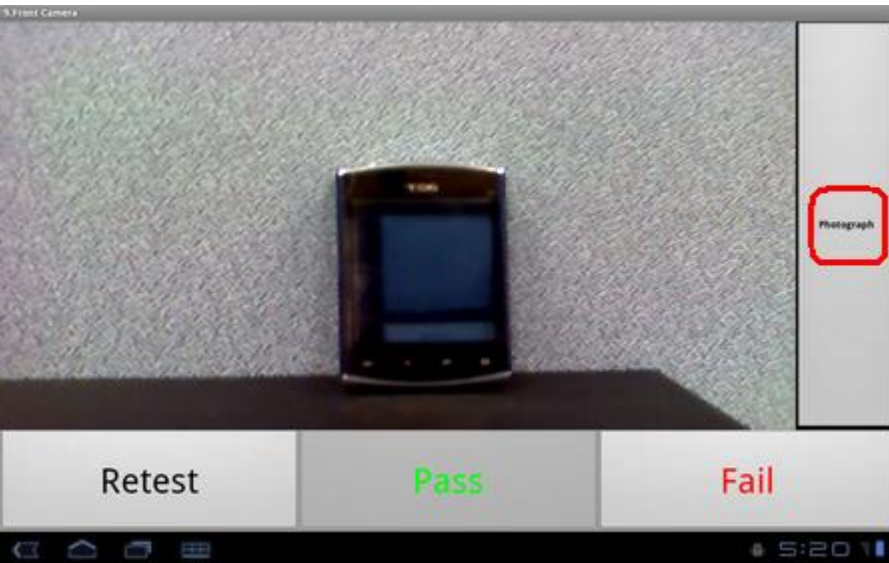
# 8. Rear Microphone

Tap screen to start the test. When “Recording” screen appears, speak into front side of device. Check if voice recorded when screen switches to “Playing” screen.



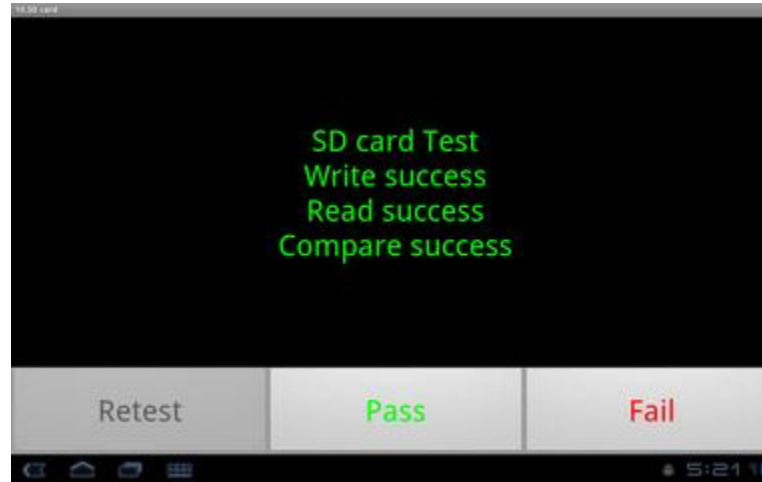
## 9. Front Camera

Point front side of device at an object. Tap “Photograph” icon to test picture taking functionality.



# 10. SD Card (SD read/write test)

Insert a micro SD card into device. Start the SD read and write test. The screen shows success if the test is passed.

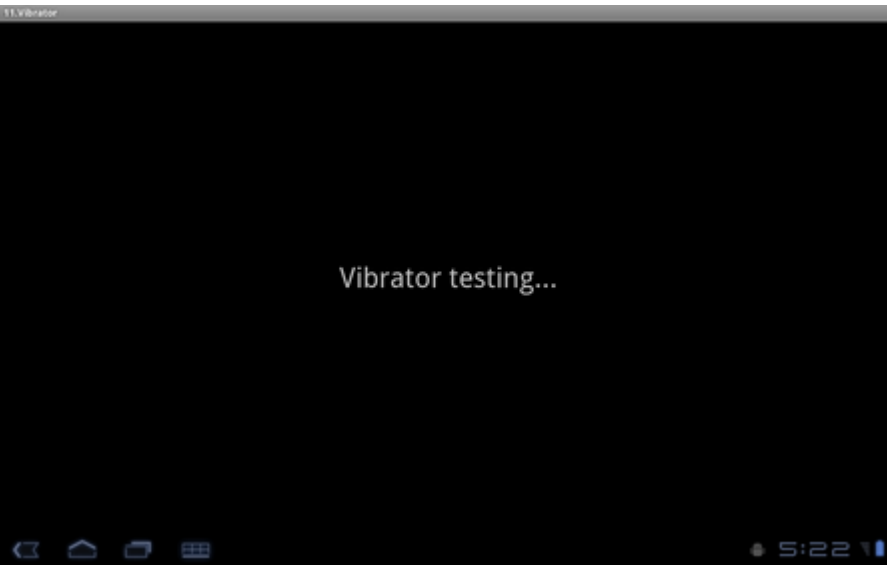


System requests to insert a micro SD if you forget to insert a card.



# 11. Vibrator

It starts vibrating for two seconds then switches to success screen if test is passed.

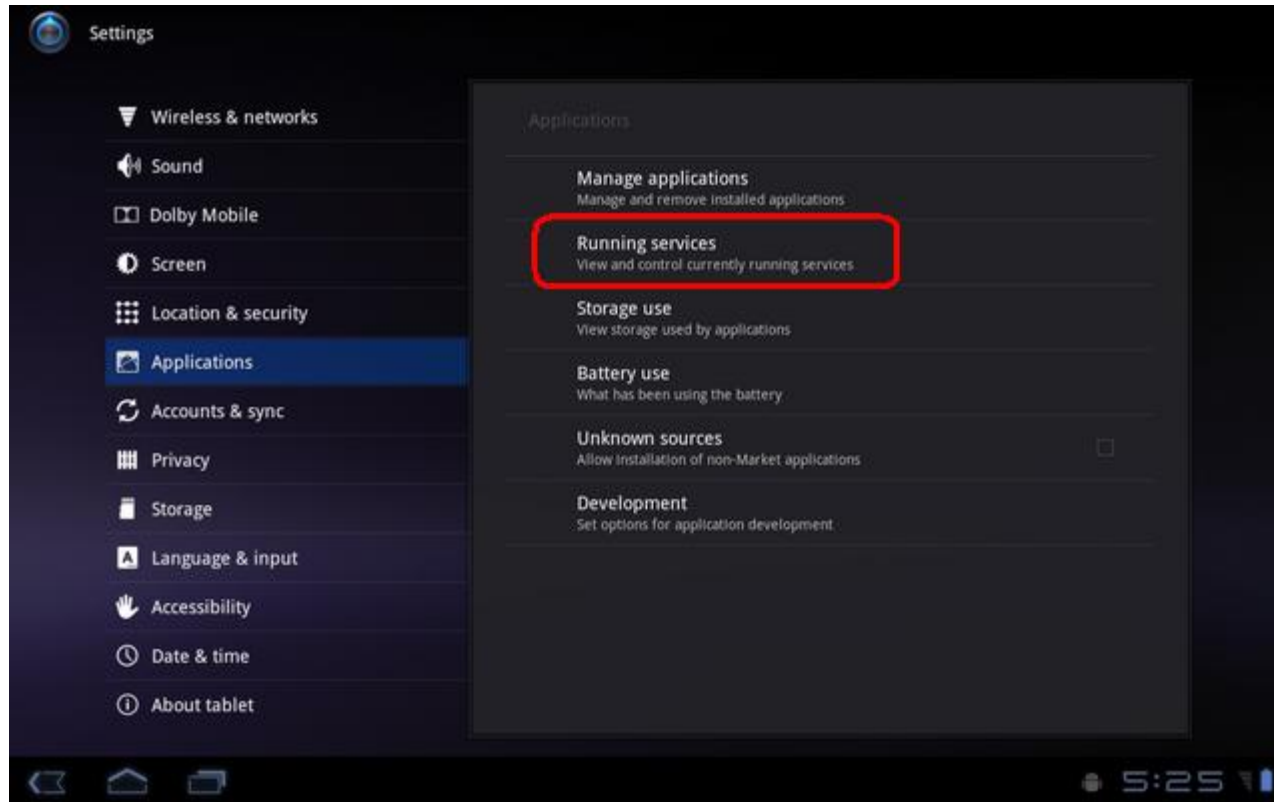


# Un-installation procedure

The diagnostic tool **MUST** be uninstalled once testing is done. **DO NOT** distribute this tool outside of the service center.

Step 1

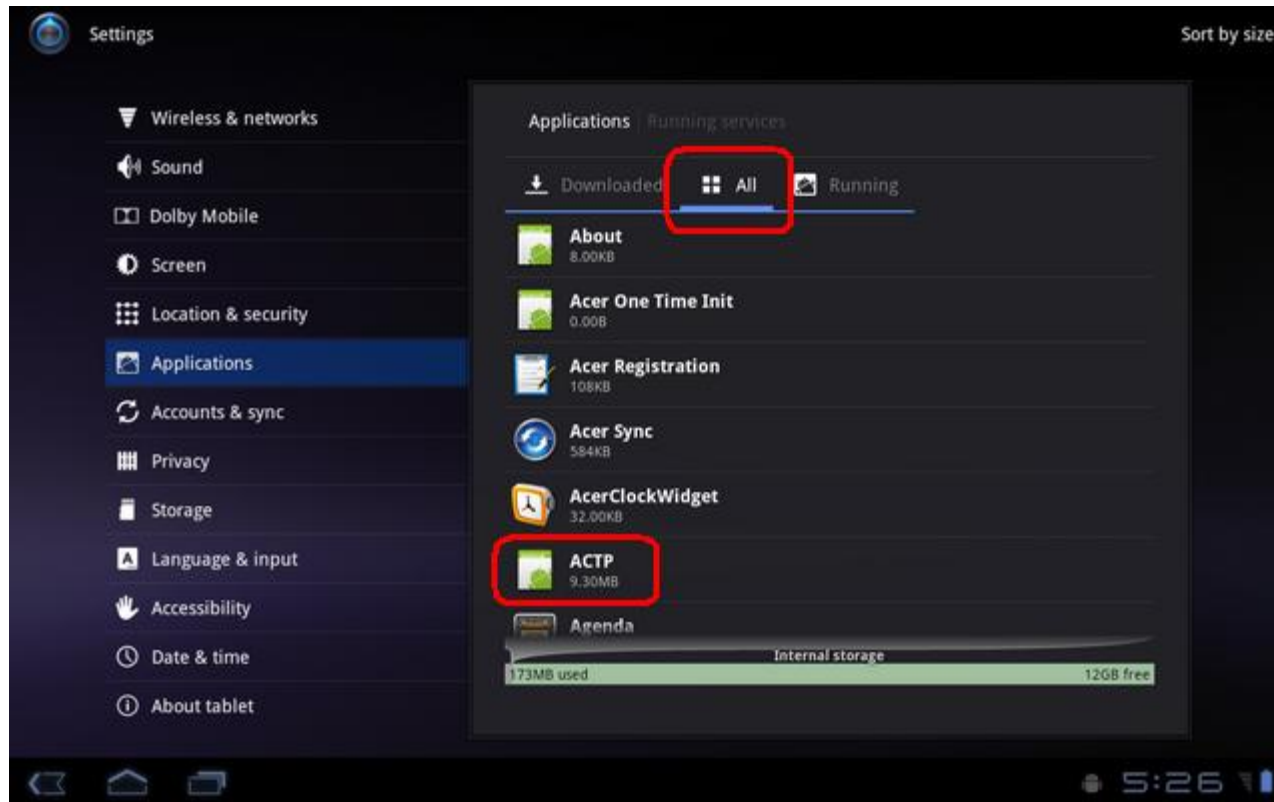
Tap “Running services” (Settings → Applications → Running services).



# Un-installation procedure

## Step 2

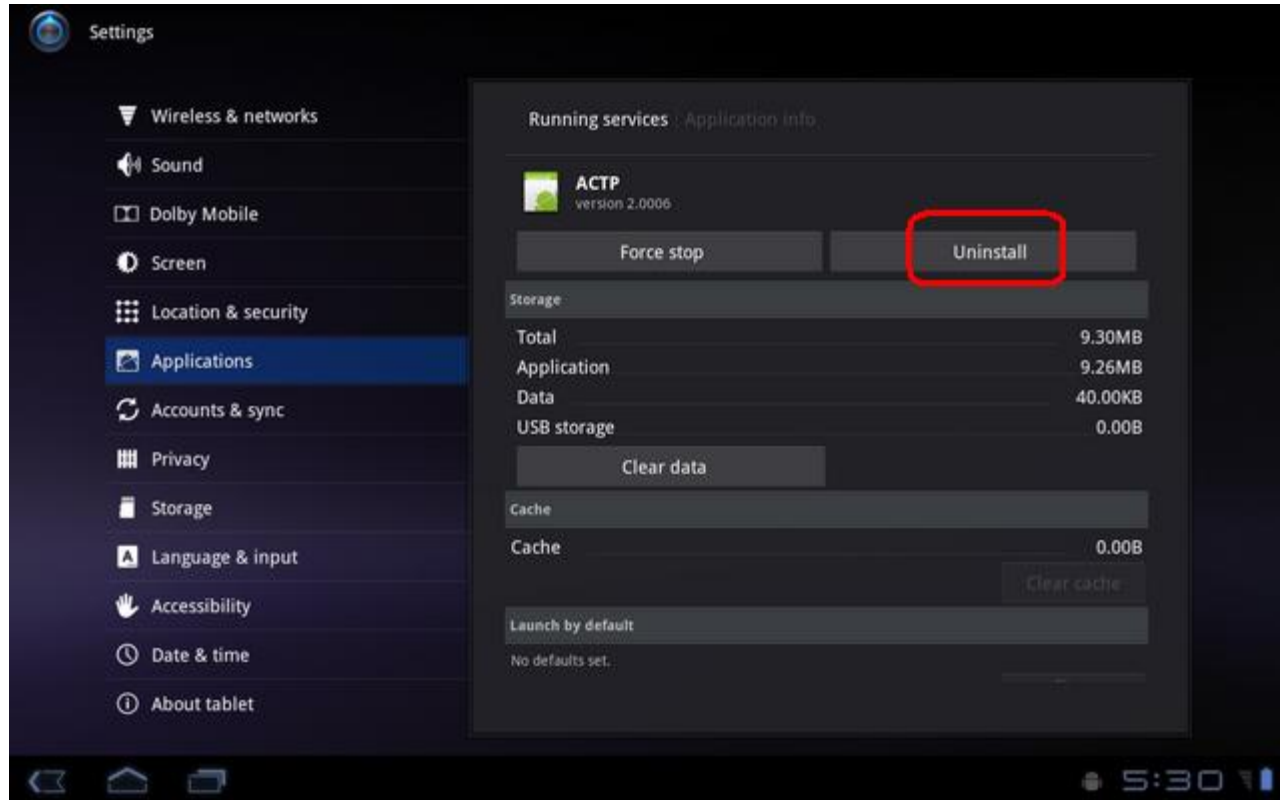
In “Running services” screen, tap “All” and select the application “ACTP”.



# Un-installation procedure

## Step 3

In ACTP application screen, select “Uninstall” to remove the tool.

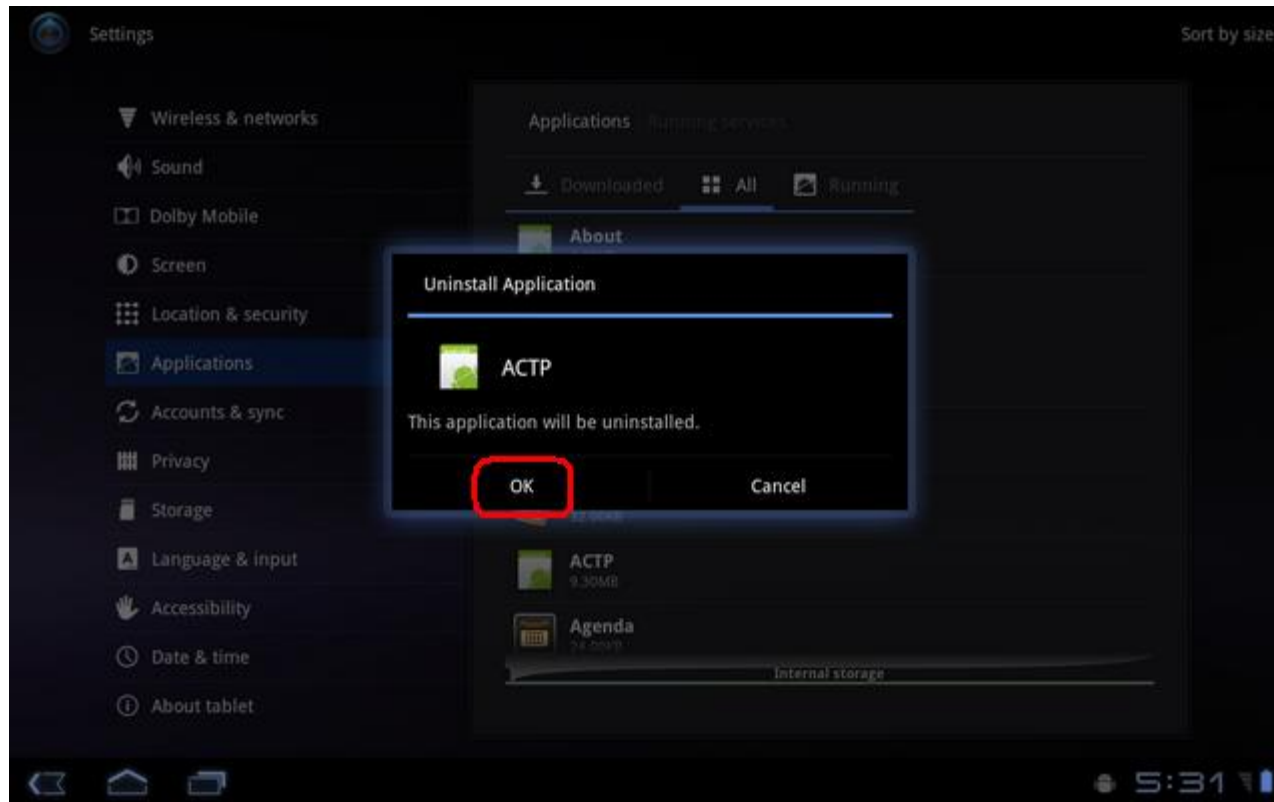




# Un-installation procedure

## Step 4

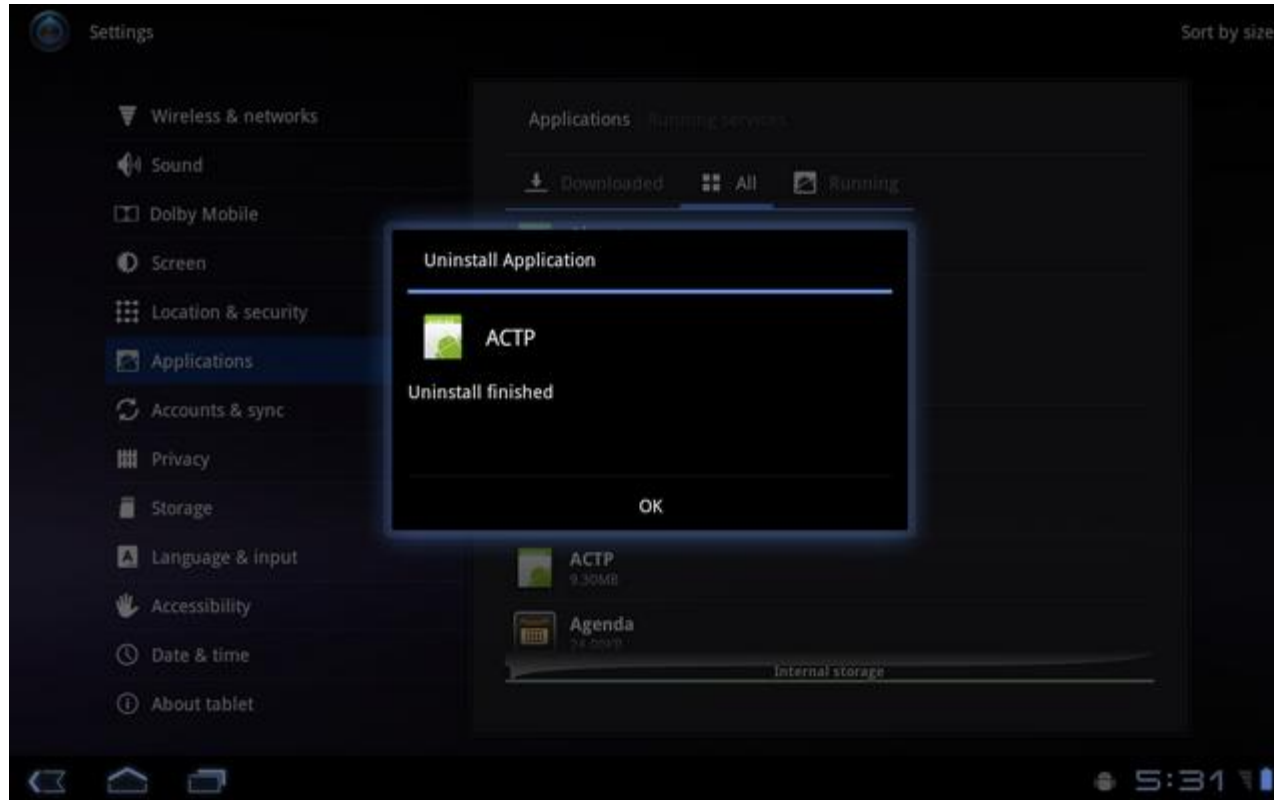
Select “OK” start to uninstall.



# Un-installation procedure

## Step 5

“Uninstall finished” message shows when the process is complete.



# Un-installation procedure

## Step 6

Make a final check to see if diagnostic tool “ACTP” has been removed from Apps.



# CHAPTER 3

## Maintenance Procedures

---

<b>Introduction</b> . . . . .	<b>3-3</b>
<b>General Information</b> . . . . .	<b>3-3</b>
<b>Recommended Equipment</b> . . . . .	<b>3-3</b>
<b>Maintenance Flowchart</b> . . . . .	<b>3-4</b>
<b>Getting Started</b> . . . . .	<b>3-5</b>
SIM/Micro-SD Card Removal . . . . .	3-6
SIM/Micro-SD Card Installation . . . . .	3-8
Lower Case Removal . . . . .	3-9
Lower Case Installation . . . . .	3-14
DC-In Cable Removal . . . . .	3-16
DC-In Cable Installation . . . . .	3-18
Battery Removal . . . . .	3-19
Battery Installation . . . . .	3-20
3G Module Removal . . . . .	3-21
3G Module Installation . . . . .	3-23
Docking Board Removal . . . . .	3-24
Docking Board Installation . . . . .	3-26
GPS Antenna Removal . . . . .	3-28
GPS Antenna Installation . . . . .	3-29
Mainboard Removal . . . . .	3-30
Mainboard Installation . . . . .	3-32
Rear CCD Removal . . . . .	3-35
Rear CCD Installation . . . . .	3-37
Front CCD Removal . . . . .	3-38
Front CCD Installation . . . . .	3-38
Two-Piece Microphone Removal . . . . .	3-39
Two-Piece Microphone Installation . . . . .	3-39
Speakers Removal . . . . .	3-41
Speakers Installation . . . . .	3-41
USB Module Removal . . . . .	3-42
USB Module Installation . . . . .	3-43
LCD Support Plate Removal . . . . .	3-44
LCD Support Plate Installation . . . . .	3-47
Control Board Removal . . . . .	3-48
Control Board Installation . . . . .	3-49
3G Antenna Removal . . . . .	3-51
3G Antenna Installation . . . . .	3-51
WLAN Antenna Removal . . . . .	3-53
WLAN Antenna Installation . . . . .	3-53

# Machine Maintenance Procedures

---

## Introduction

---

This chapter contains general information about the notebook, a list of tools needed to perform the required maintenance and step by step procedures on how to remove and install components from the notebook computer.

## General Information

---

The product previews seen in the following procedures may not represent the final product color or configuration. Cable paths and positioning may also differ from the actual model. During the removal and installation of components, make sure all available cable channels and clips are used and that the cables are installed in the same position.

All prerequisites must be performed prior to performing maintenance.

## Recommended Equipment

---

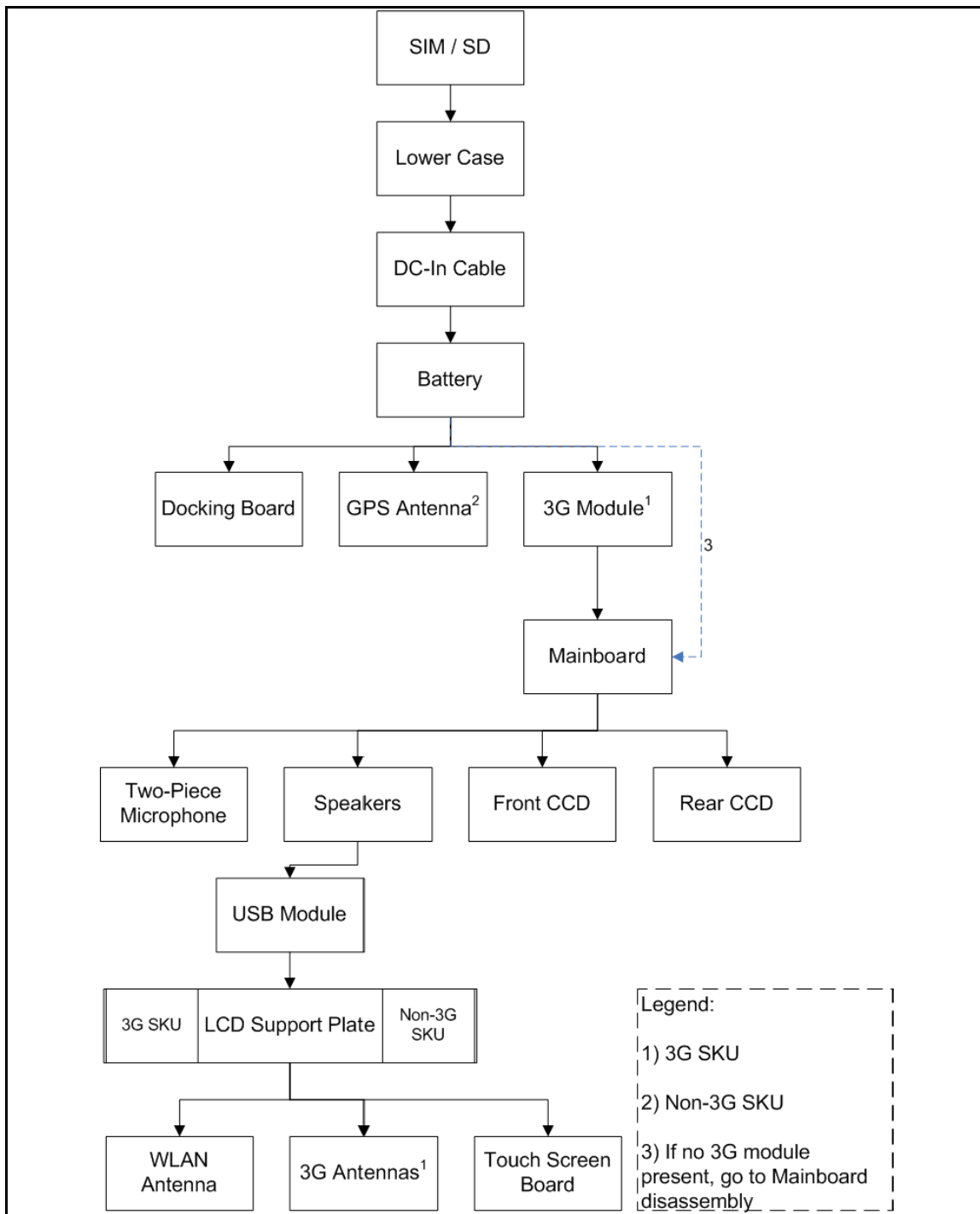
The following tools are required to perform maintenance on the notebook:

- Wrist grounding strap and conductive mat
- Flat screwdriver
- Philips screwdriver

Screw Name	Quantity
M1.6x5.0 Ni	4
M2.0x4.0 Ni	16
M2.0x3.0	9

# Maintenance Flowchart

The flowchart in Figure 3-1 provides a graphic representation of the module removal and installation sequences. It provides information on what components need to be removed and installed during servicing.



**Figure 3-1. Maintenance Flow**

# Getting Started

---

The flowchart (Figure 3-1) identifies sections illustrating the entire removal and install sequence. Observe the order of the sequence to avoid damage to any of the hardware components.

Perform the following prior to performing any maintenance procedures:

1. Place system on a flat work surface.
2. Disconnect AC Adapter and remove all cables from system and peripherals.
3. Make sure system is completely powered down.
4. To make sure system is completely powered down, press and hold power button (A) for 4 seconds. (Figure 3-2)
  - a. If the device is in powered down mode, allow device to complete boot process (approx. 10 sec.). Then power down normally.
  - b. If device is in sleep mode, wait for Home Screen to clear. Then power down normally.



---

**Figure 3-2. Device Overview with Power Button**

5. Press and hold Power button for 4 seconds to show Tablet Options dialog.
6. Select Power Off to power down device.
7. From Power Off dialog, select OK.



## SIM/Micro-SD Card Removal

---

1. Open SIM/Micro-SD card cover. (Figure 3-3)



---

**Figure 3-3. Opening SIM/Micro-SD Card Cover**

2. Remove SIM card from spring locking mechanism. (Figure 3-4)



---

**Figure 3-4. Removing SIM Card**

3. Remove Micro-SD card from spring locking mechanism. (Figure 3-5)



---

**Figure 3-5. Removing Micro-SD Card**

4. Secure SIM/Micro-SD card cover. (Figure 3-6)



---

**Figure 3-6. Securing SIM/Micro-SD Card Cover**

## SIM/Micro-SD Card Installation

---

1. Open SIM/Micro-SD card cover. ([Figure 3-3](#))
2. Install and secure SIM card. ([Figure 3-4](#))
3. Install and secure Micro-SD card. ([Figure 3-5](#))
4. Close and secure SIM/Micro-SD card cover. ([Figure 3-6](#))

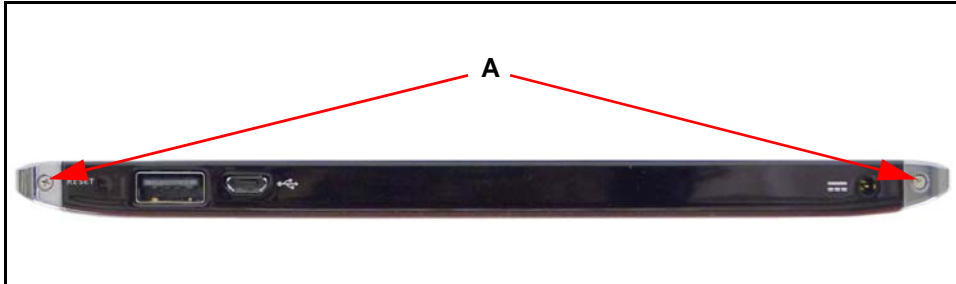
# Lower Case Removal

---

## Prerequisite:

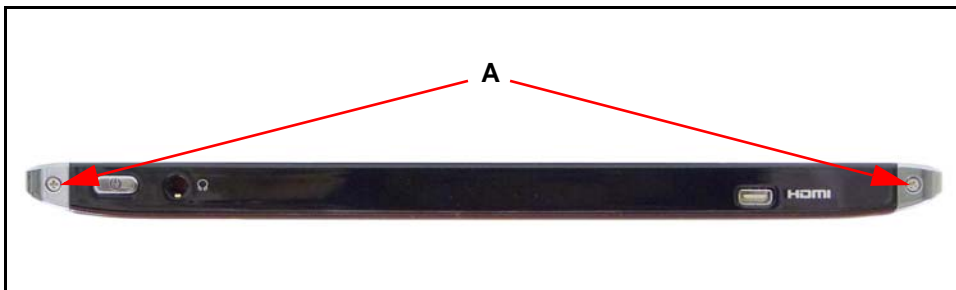
[SIM/Micro-SD Card Removal](#)

1. Remove screws (A) from the top and bottom caps. (Figure 3-7 and Figure 3-8)



---

**Figure 3-7. Top and Bottom Cap Screws (1 of 2)**



---

**Figure 3-8. Top and Bottom Cap Screws (2 of 2)**

2. Release the corner of the top cap from the locking latches of the bezel as shown in Figure 3-9.



---

**Figure 3-9. Removing the Top Cap (1 of 3)**

3. Release the top cap from the remaining locking latches of the bezel. (Figure 3-10)



---

**Figure 3-10. Removing the Top Cap (2 of 3)**

4. Remove the top cap from the bezel. (Figure 3-11)



---

**Figure 3-11. Removing Top Cap (3 of 3)**

5. Release the corner of the bottom cap from the locking latches of the bezel as shown in Figure 3-12.



**Figure 3-12. Removing the Bottom Cap (1 of 3)**

6. Release the bottom cap from the remaining locking latches of the bezel. (Figure 3-13)



**Figure 3-13. Removing the Bottom Cap (2 of 3)**

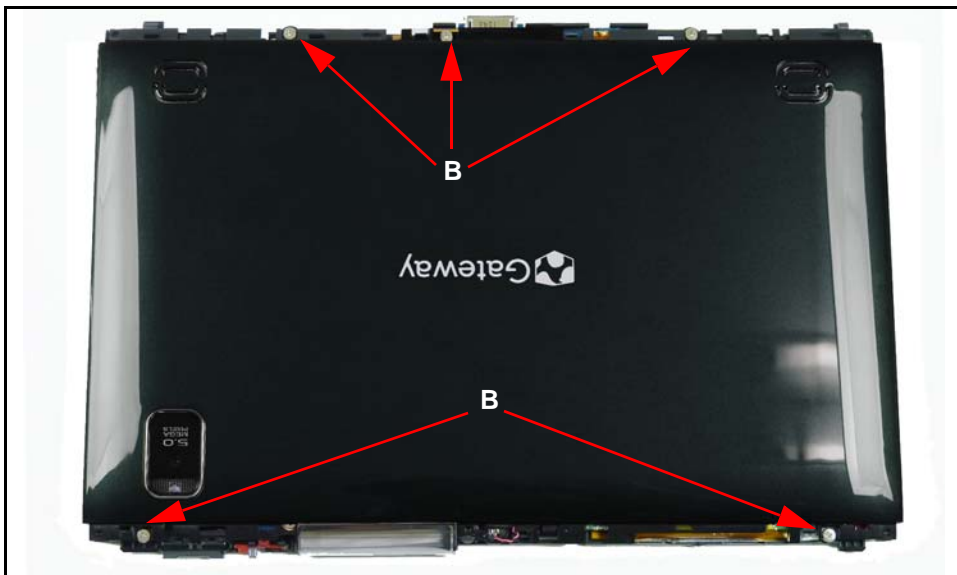


7. Remove the bottom cap from the bezel. (Figure 3-14)



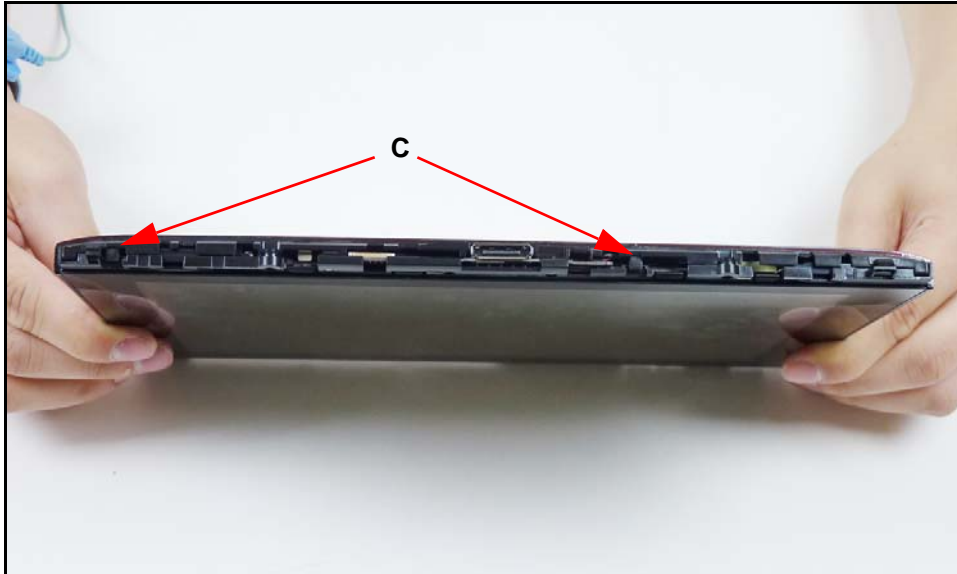
**Figure 3-14. Removing the Bottom Cap (3 of 3)**

8. Remove screws (B) from the bezel. (Figure 3-15)



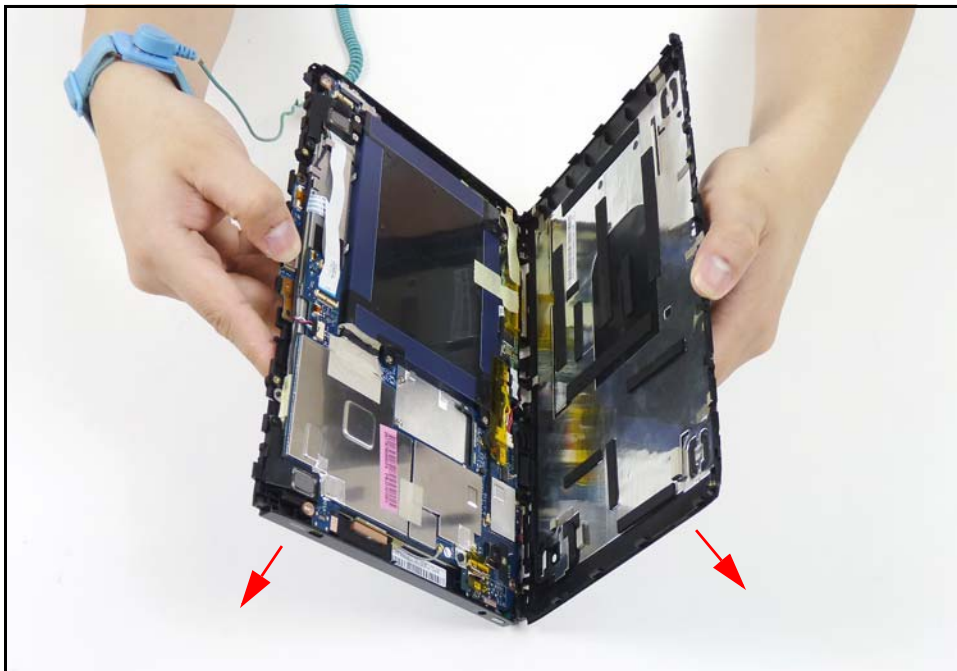
**Figure 3-15. Bezel Screws**

9. Release the lower case from the two locking latches (C) on the bottom side of the bezel. (Figure 3-16)



**Figure 3-16. Bezel Locking Latches: Bottom Side**

10. Release the right, left and top sides of the lower case from the locking latches of the bezel. (Figure 3-17)



**Figure 3-17. Releasing the Remaining Latches**

11. Remove the lower case from the bezel.



## Lower Case Installation

---

1. Make sure the SD card cover (D) is in the open position before installing the lower case. (Figure 3-18)



---

**Figure 3-18. Installing the Lower Case (1 of 3)**

1. Align the bottom edge of the lower case with the guides (E) on the bezel. (Figure 3-19)



---



**Figure 3-19. Installing the Lower Case (2 of 3)**

2. Secure the lower case to the two locking latches (C) on the bottom side of the bezel. (Figure 3-16)
3. Secure the remaining sides of the lower case to the locking latches of the bezel. (Figure 3-20)



**Figure 3-20. Installing the Lower Case (3 of 3)**

4. Install and secure the screws (B) to the bezel. (Figure 3-15)
5. Install and secure the bottom cap to the bezel locking latches. (Figure 3-14 to Figure 3-12)
6. Install and secure the top cap to the bezel locking latches. (Figure 3-11 to Figure 3-9)
7. Install and secure the top and bottom cap screws. (Figure 3-7 and Figure 3-8)
8. Install SIM/Micro-SD card.

ID	Size	Quantity	Screw Type
A	M1.6x5.0 Ni	4	
B	M2.0x4.0 Ni	5	

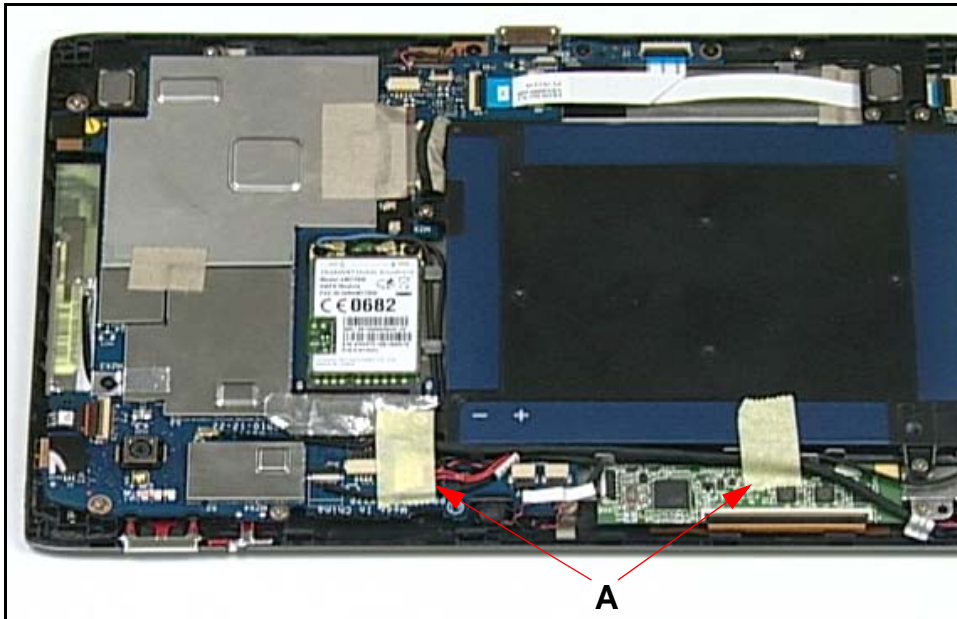
# DC-In Cable Removal

---

## Prerequisite:

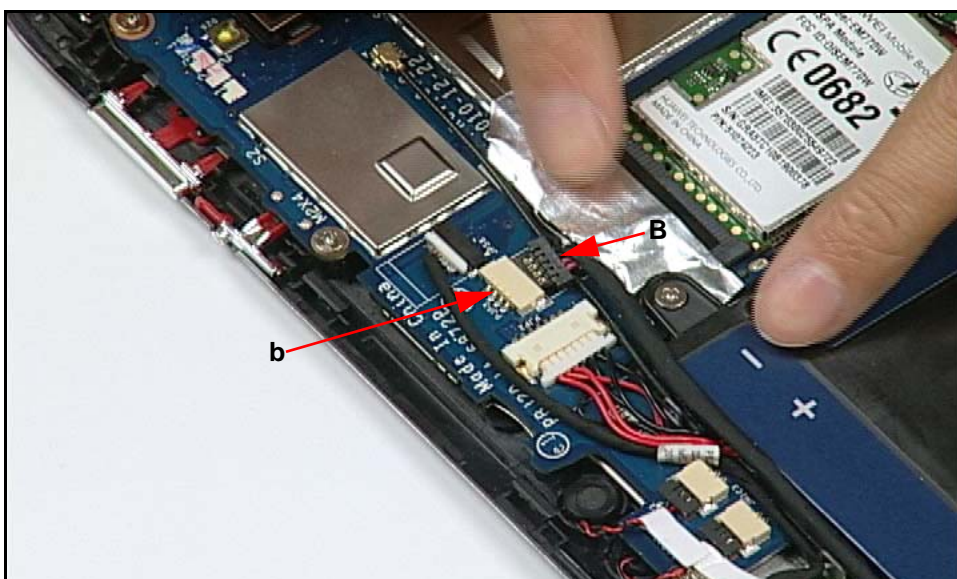
[Lower Case Removal](#)

1. Remove tape (A) covering DC-In and antenna cables. (Figure 3-21)



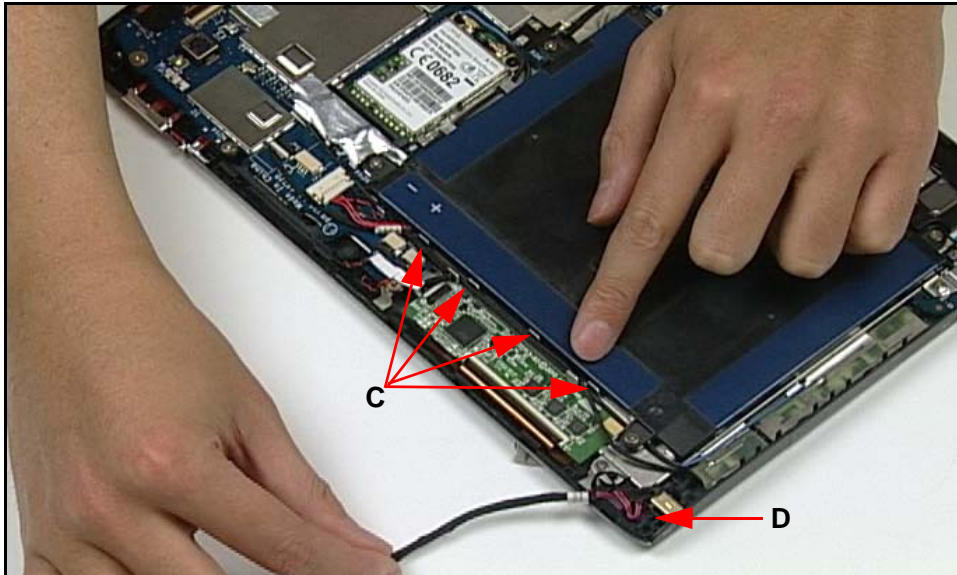
**Figure 3-21. Removing Protective Tape**

2. Disconnect DC-In cable (B) from mainboard connector (b). (Figure 3-22)



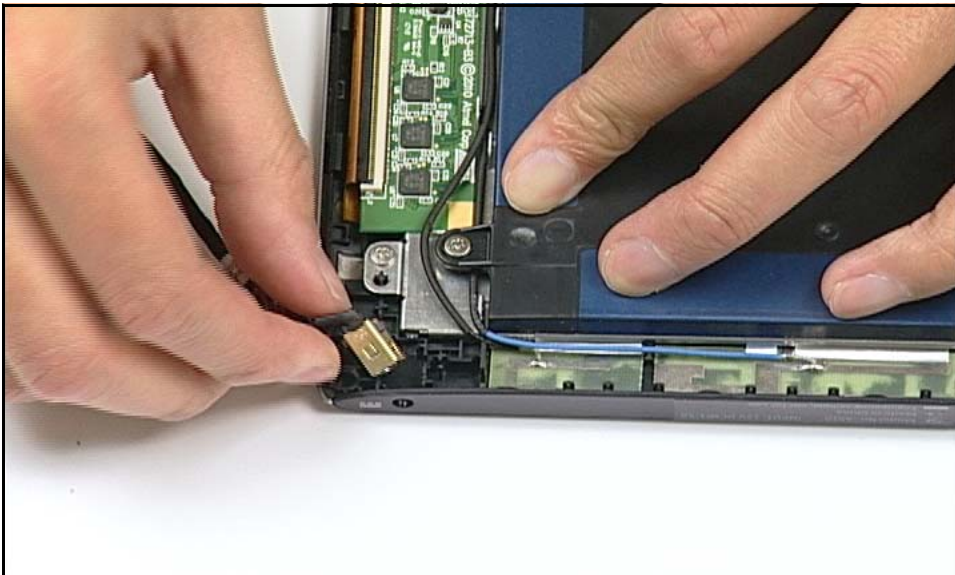
**Figure 3-22. Disconnecting DC-In Cable**

3. Remove DC-In cable from the LCD support plate (C) and bezel (D) guides. (Figure 3-23)



**Figure 3-23. Removing DC-In Cable**

4. Remove DC-In jack from bezel. (Figure 3-24)



**Figure 3-24. Removing DC-In Jack**

## DC-In Cable Installation

---

1. Install and secure DC-In jack on bezel. (Figure 3-24)
2. Connect DC-In cable (B) to mainboard connector (b). (Figure 3-22)
3. Install and secure DC-In cable to bezel (D) and LCD support plate (C) guides. (Figure 3-23)
4. Install and secure tape (A) covering DC-In and antenna cables. (Figure 3-21)
5. Install lower case.



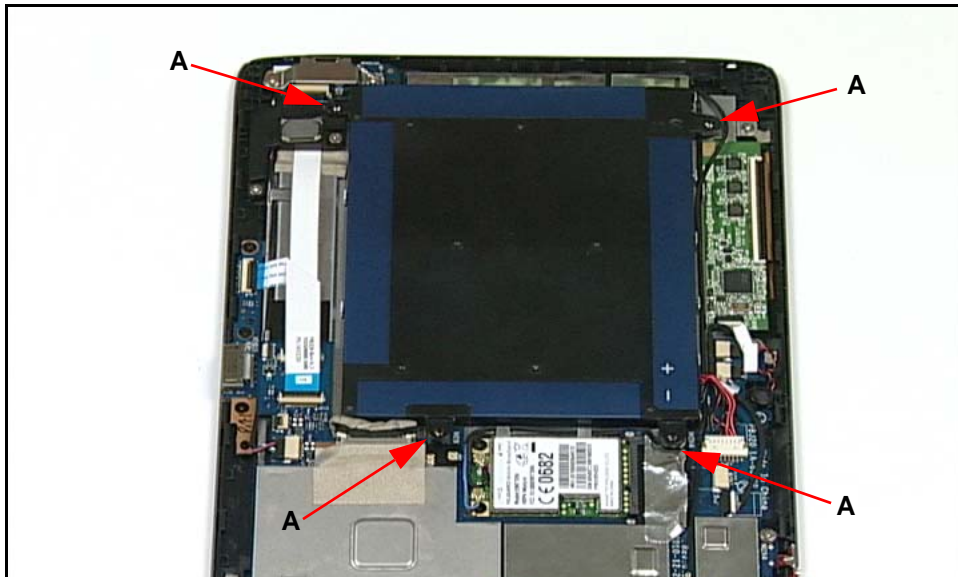
# Battery Removal

---

## Prerequisite:

### [DC-In Cable Removal](#)

1. Remove screws (A) from LCD support plate. (Figure 3-25)



---

**Figure 3-25. Removing Battery Screws**

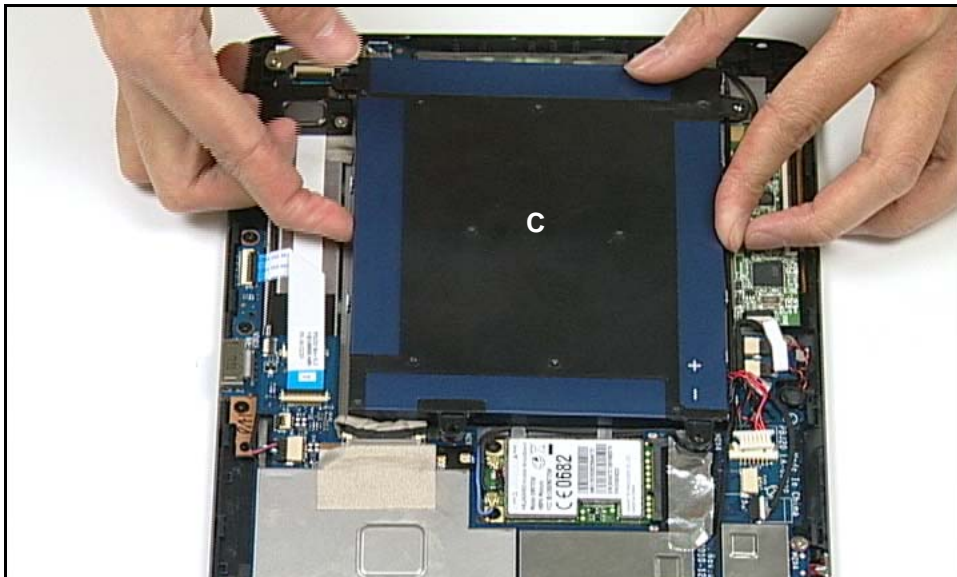
2. Disconnect battery cable (B) from mainboard connector (b). (Figure 3-26)



---

**Figure 3-26. Disconnecting Battery Cable**


3. Remove battery (C). (Figure 3-27)



**Figure 3-27. Removing Battery**

## Battery Installation

1. Install battery (C) on LCD support plate. (Figure 3-27)
2. Connect battery cable (B) to mainboard connector (b). (Figure 3-26)
3. Install and secure screws (A) to LCD support plate. (Figure 3-25)
4. Install DC-In cable.

ID	Size	Quantity	Screw Type
A	M2.0x4.0 Ni	4	

## 3G Module Removal

---

### Prerequisite:

#### Battery Removal

1. Locate 3G module (A) on LCD support plate. (Figure 3-28)



**Figure 3-28. 3G Module on LCD Support Plate**

2. Disconnect auxiliary (blue) and main (black) cables from 3G module connectors. (Figure 3-29)



**Figure 3-29. Disconnecting 3G Cables**

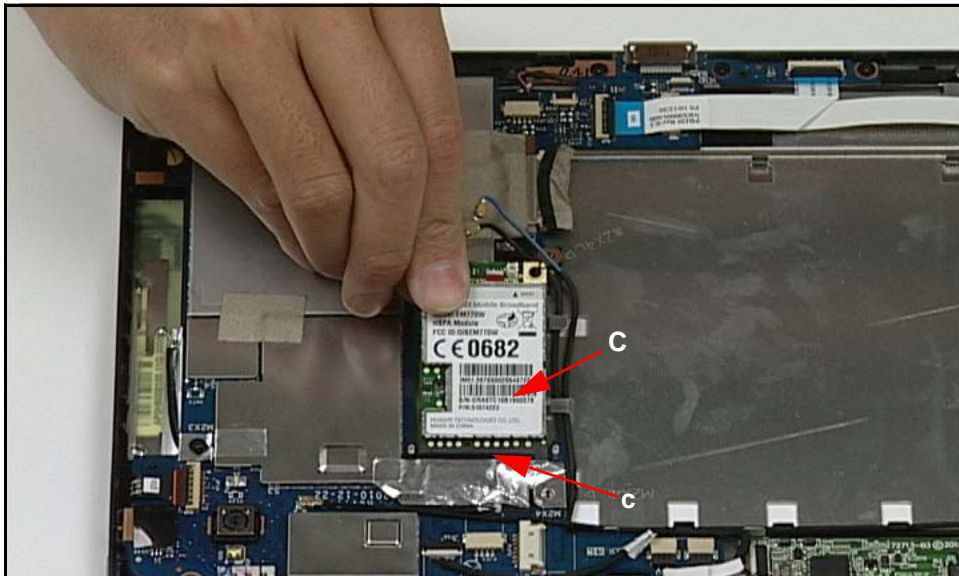


3. Remove screws (B) from LCD support plate. (Figure 3-30)



**Figure 3-30. Removing 3G Module Screws**

4. Remove 3G module (C) from mainboard connector (c). (Figure 3-31)




**Figure 3-31. Removing 3G Module**

## 3G Module Installation

---

1. Install and connect 3G module (C) to mainboard connector (c). (Figure 3-31)
2. Install and secure screws (B) to LCD support plate. (Figure 3-30)
3. Connect main 3G antenna cable (black) to 3G module connector labeled M. (Figure 3-29)
4. Connect auxiliary 3G antenna cable (blue) to 3G module connector labeled A.
5. Install battery.

ID	Size	Quantity	Screw Type
B	M2.0x3.0	2	

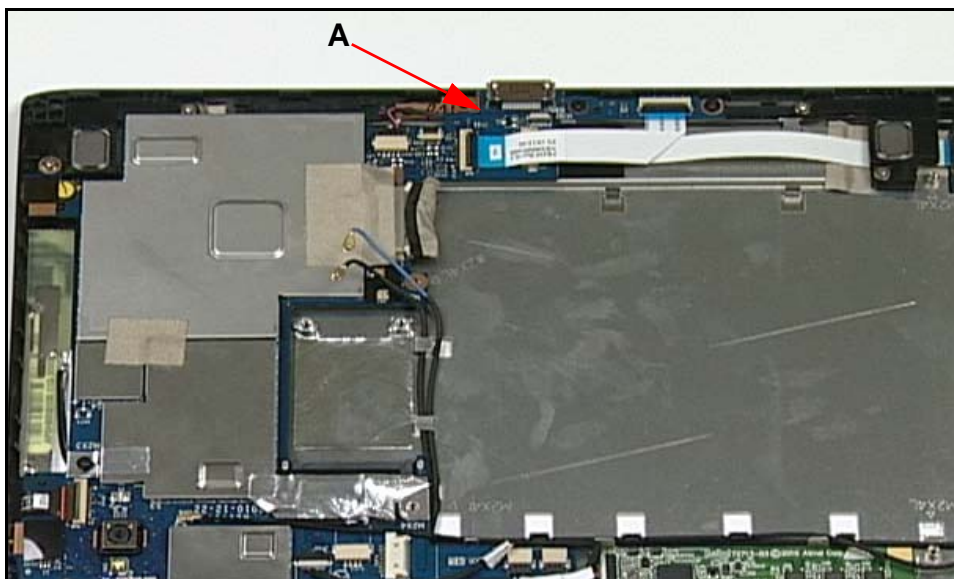
# Docking Board Removal

---

## Prerequisite:

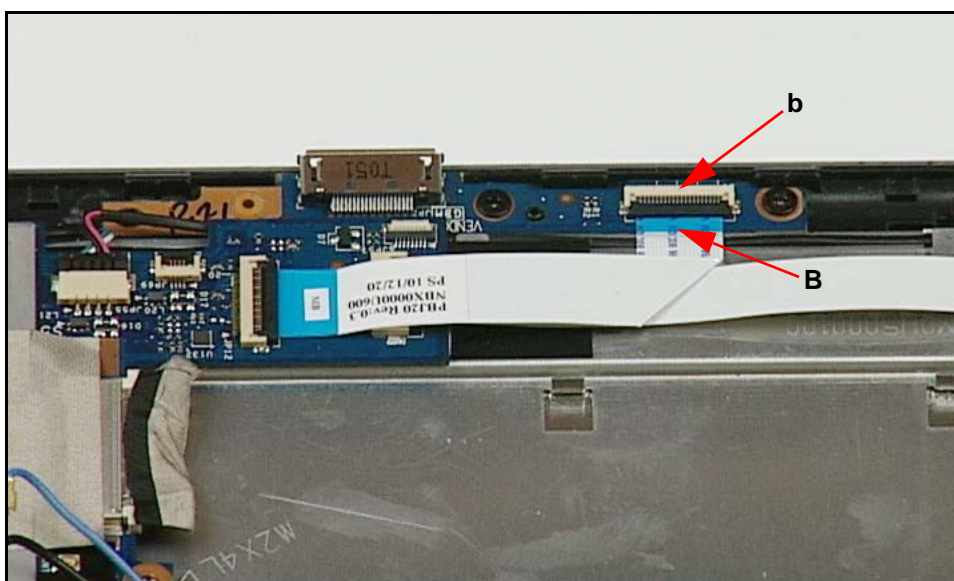
### Battery Removal

1. Locate Docking Board (A). (Figure 3-32)



**Figure 3-32. Docking Board Overview**

2. Disconnect docking board FFC (B) from docking board connector (b). (Figure 3-33)



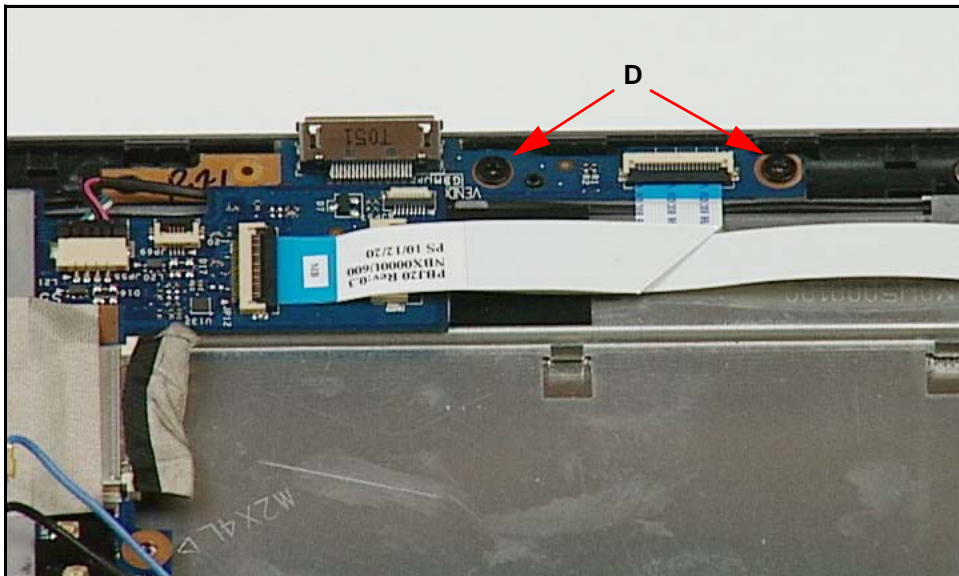
**Figure 3-33. Disconnecting Docking Board FFC from Docking Board**

3. Disconnect docking board FFC (C), labeled MB, from mainboard connector (c). (Figure 3-34)



**Figure 3-34. Disconnecting Docking Board FFC from Mainboard**

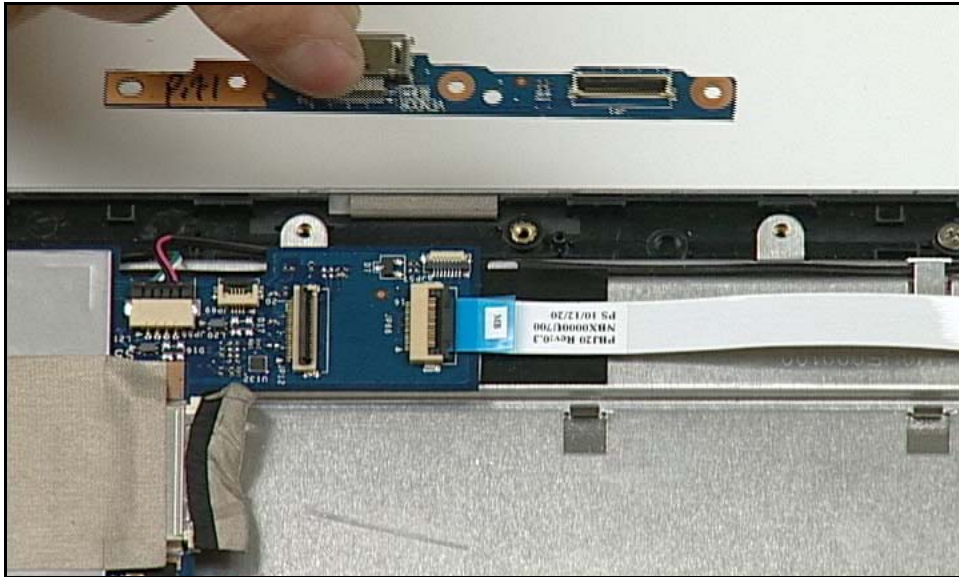
4. Remove screws (D) from bezel. (Figure 3-35)



**Figure 3-35. Removing Docking Board Screws**



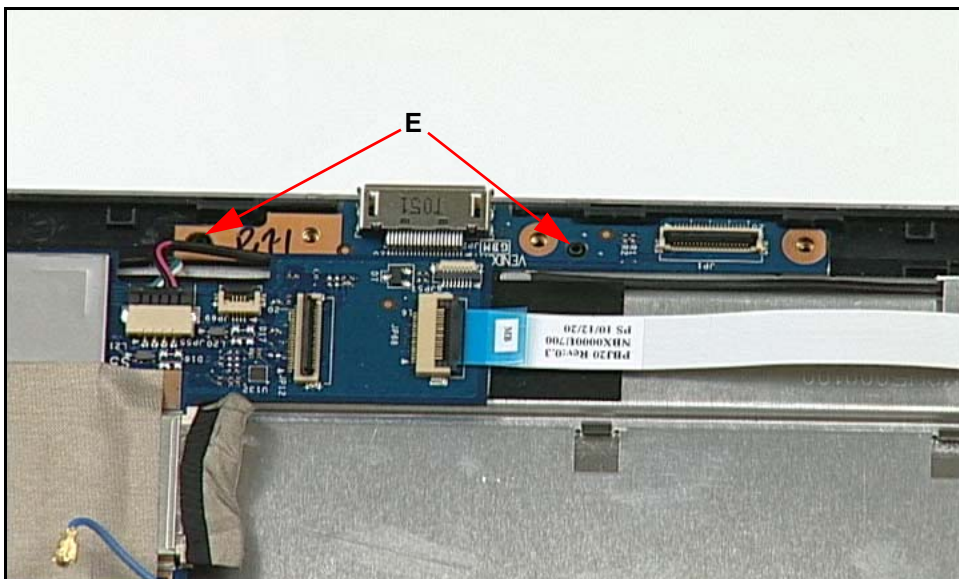
5. Remove docking board from bezel. (Figure 3-36)



**Figure 3-36. Removing Docking Board**

## Docking Board Installation


1. Align docking board with bezel guides (E). (Figure 3-37)



**Figure 3-37. Aligning Docking Board Bezel Guides**

2. Install board on bezel. (Figure 3-36)
3. Install and secure screws (D) to bezel. ([Figure 3-35](#))

4. Install and connect docking board FFC (C), labeled MB, to mainboard connector (c). (Figure 3-34)
5. Install and connect docking board FFC (B) to docking board connector (b). (Figure 3-33)
6. Install battery.

ID	Size	Quantity	Screw Type
D	M2.0x3.0	2	

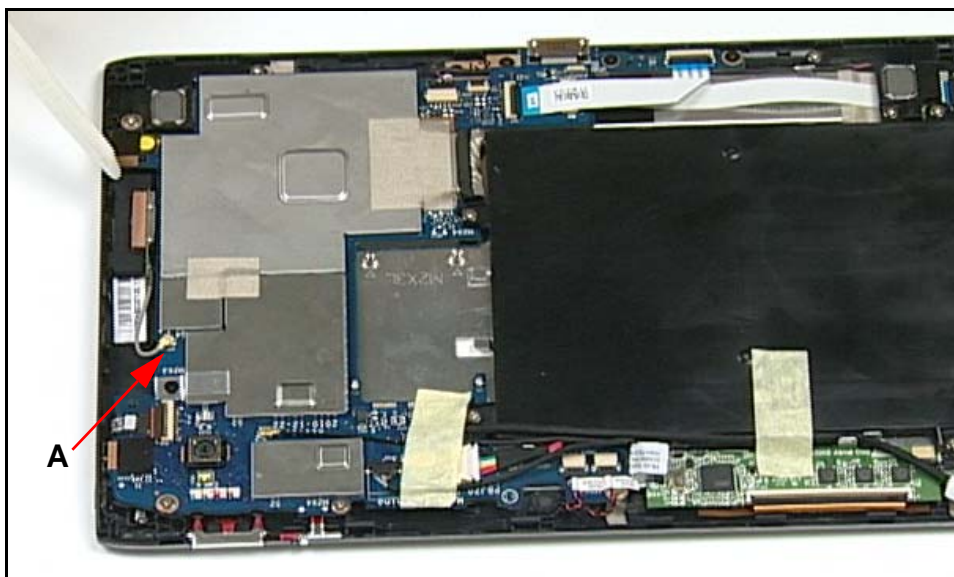
# GPS Antenna Removal

---

## Prerequisite:

[Battery Removal](#)

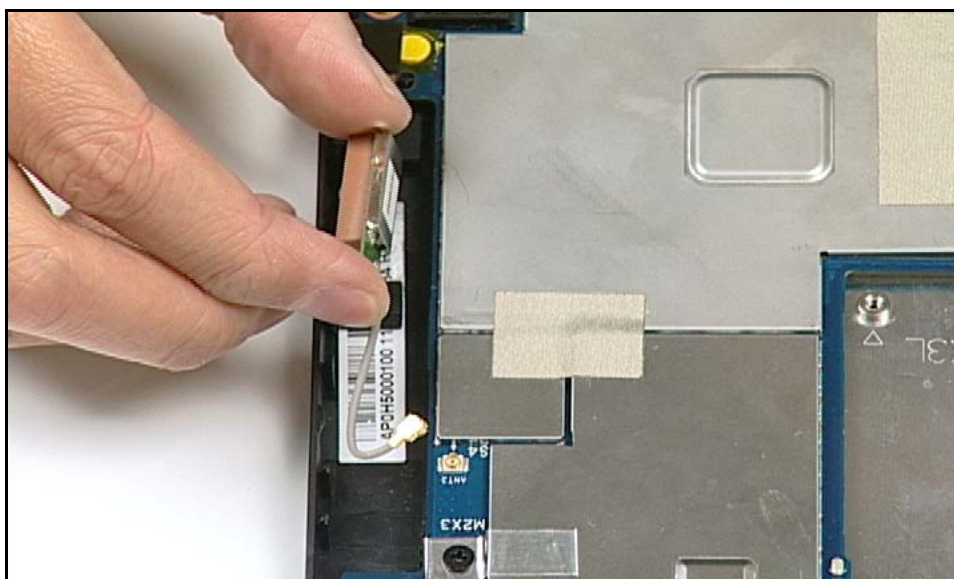
1. Disconnect GPS antenna (A) from mainboard connector. (Figure 3-38)



---

**Figure 3-38. Disconnecting GPS Antenna**

2. Remove GPS module. (Figure 3-39)



---

**Figure 3-39. Removing GPS Module**

## GPS Antenna Installation

---

1. Install GPS module on bezel. ([Figure 3-39](#))
2. Connect GPS antenna (A) to mainboard connector. ([Figure 3-38](#))
3. Install battery.



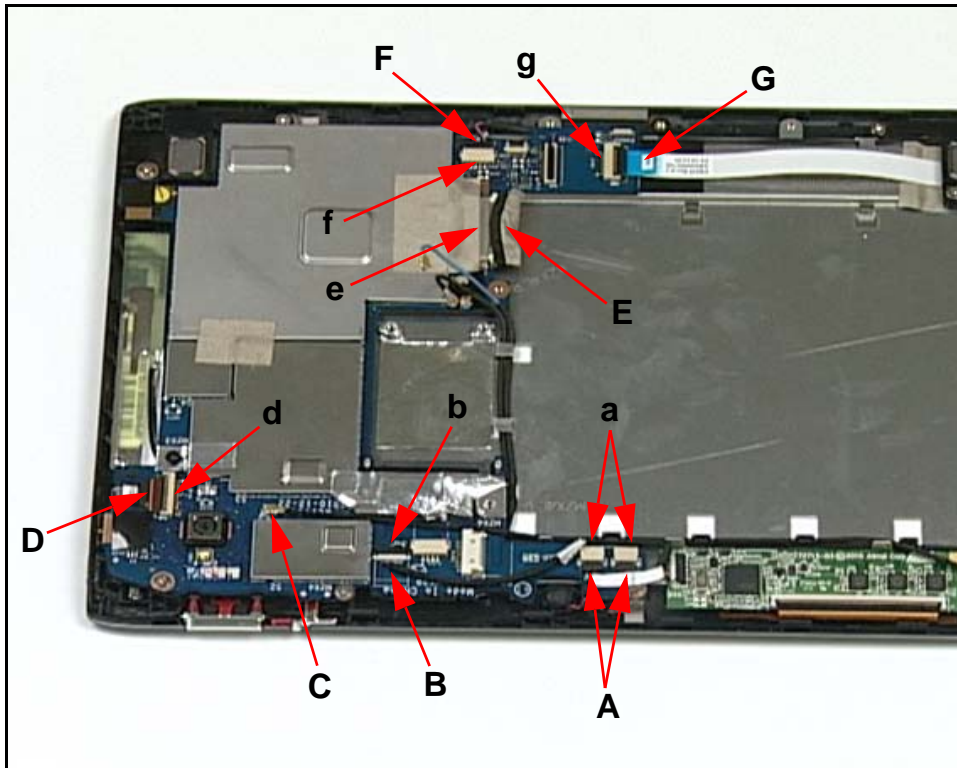
# Mainboard Removal

---

## Prerequisite:

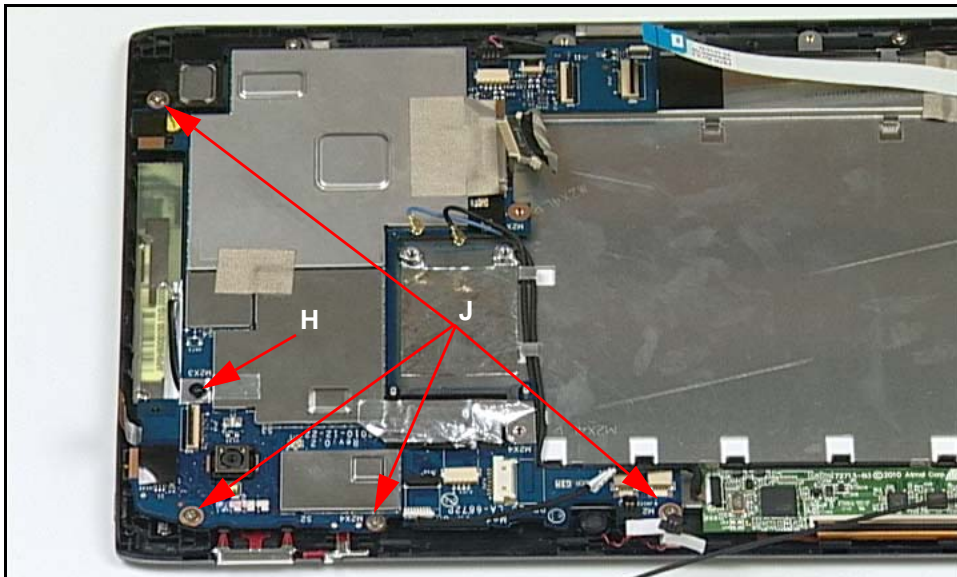
### 3G Module Removal

1. Disconnect the following cables: (Figure 3-40)
  - Front and rear microphone cables (A) from mainboard connectors (a)
  - Control board cable (B) from mainboard connector (b)
  - Main (black) WLAN cable (C) from mainboard connector (c)
  - Front camera FFC (D) from mainboard connector (d)
  - LVDS cable (E) from mainboard connector (e)
  - Speaker cable (F) from mainboard connector (f)
  - USB FFC (G) from mainboard connector (g)



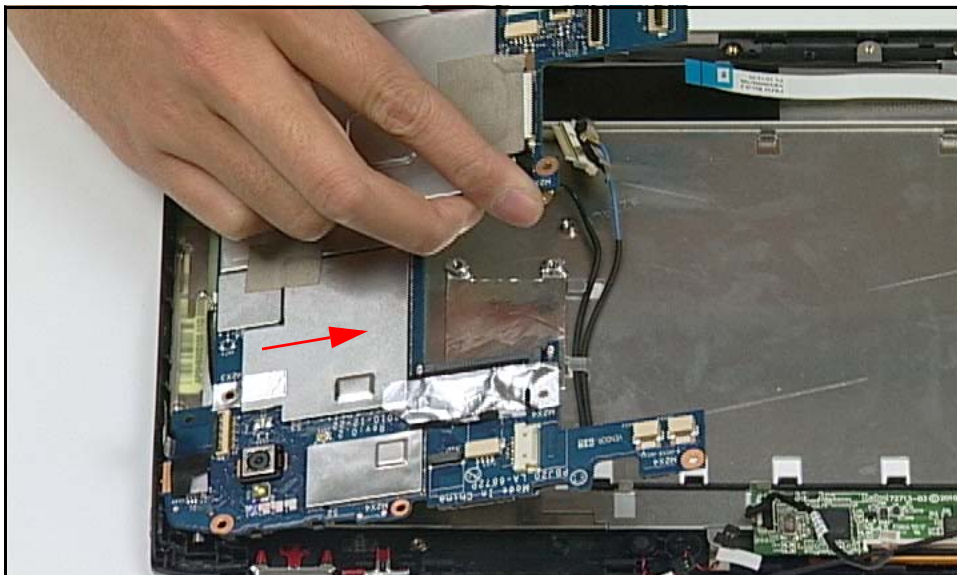
**Figure 3-40. Disconnecting Cables from Mainboard**

2. Remove screw (H) and screws (J) from bezel. (Figure 3-41)



**Figure 3-41. Removing Mainboard Screws**

3. Lift and remove mainboard from bezel. (Figure 3-42)



**Figure 3-42. Removing Mainboard**

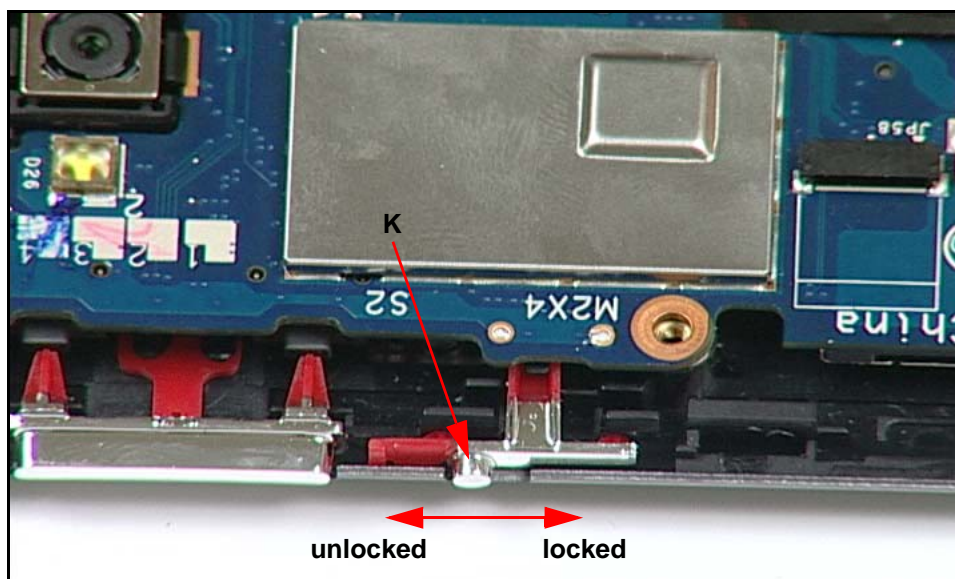
## Mainboard Installation

---

### ⚠ CAUTION:

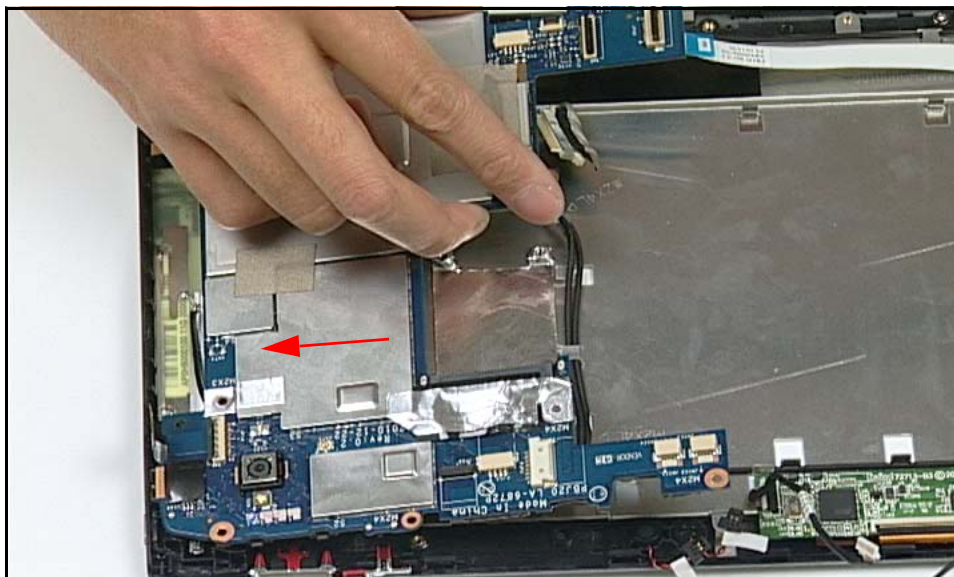
The touch screen lock button guides may be damaged when the mainboard screws are secured. Make sure to align the touch screen lock button switch with the lock button guides.

1. Set touch screen lock button (K) to unlock position. (Figure 3-43)



**Figure 3-43. Setting Touch Screen Lock Button**

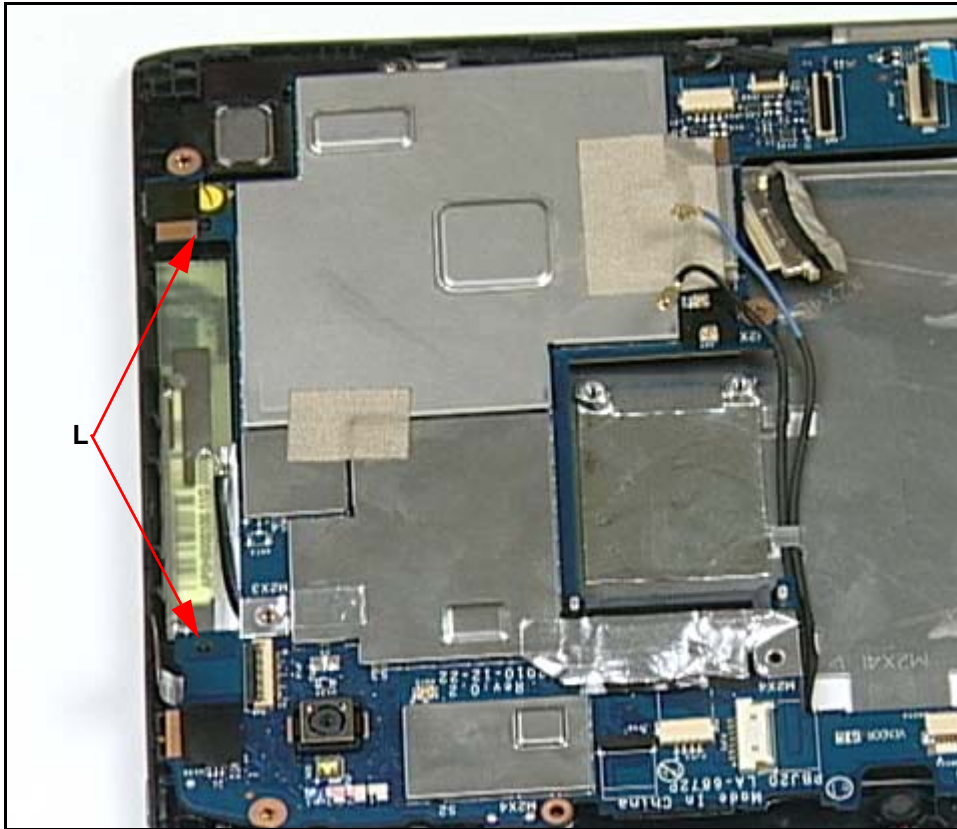
2. Install mainboard on bezel. (Figure 3-44)



**Figure 3-44. Install Mainboard**

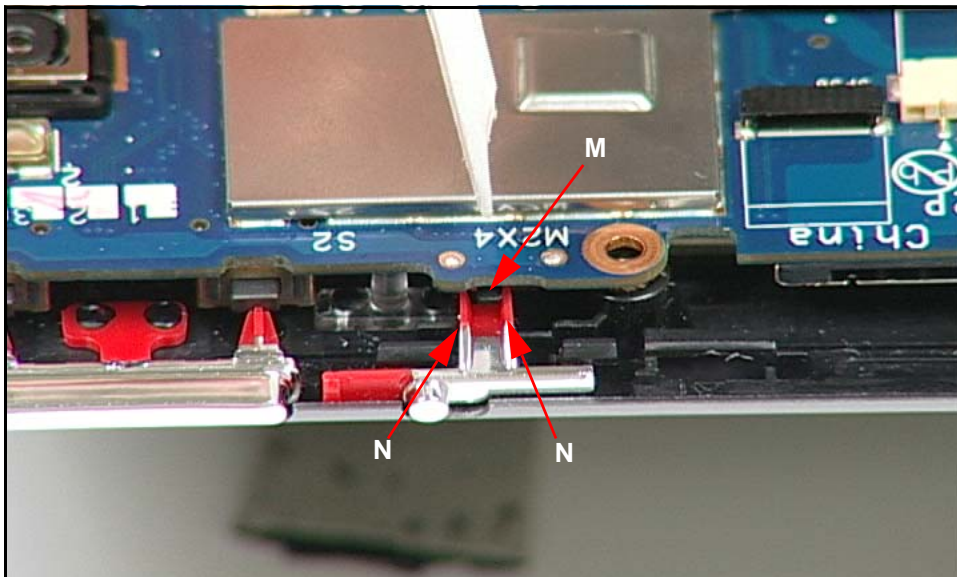


3. Align with bezel guide pins (L). (Figure 3-45)





**Figure 3-45. Aligning Mainboard with Bezel Guide Pins**

4. Align touch screen lock button switch (M) with lock button guides (N). (Figure 3-46)



**Figure 3-46. Install Mainboard to IO Ports**

5. Install and secure screw (H) and screws (J) to bezel. (Figure 3-41)
6. Connect the following cables: (Figure 3-40)
  - Front and rear microphone cables (A) to mainboard connectors (a)
  - Control board cable (B) to mainboard connector (b)
  - Main (black) WLAN cable (C) to mainboard connector (c)
  - Front camera FFC (D) to mainboard connector (d)
  - LVDS cable (E) to mainboard connector (e)
  - Speaker cable (F) to mainboard connector (f)
  - USB FFC (G) to mainboard connector (g)
7. Install 3G module (3G SKU)/Battery (Non-3G SKU)

ID	Size	Quantity	Screw Type
H	M2.0x3.0	1	
J	M2.0x4.0 Ni	4	

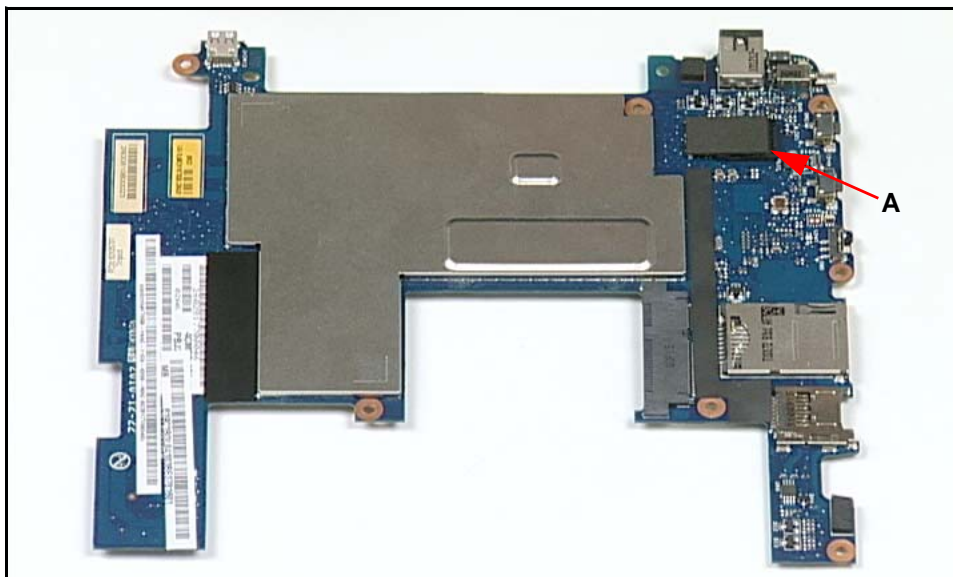
## Rear CCD Removal

---

### Prerequisite:

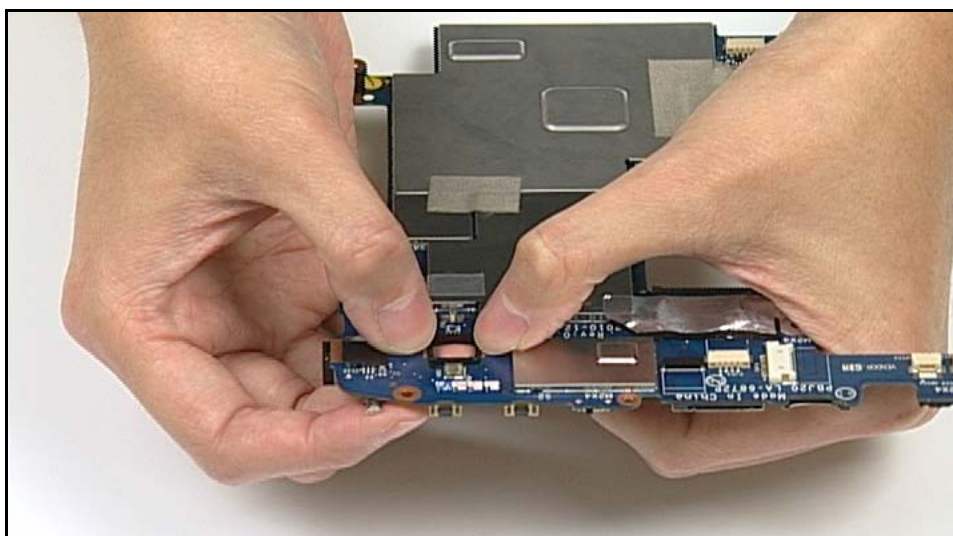
[Mainboard Removal](#)

1. Place bottom of mainboard on a flat surface.(Figure 3-47)

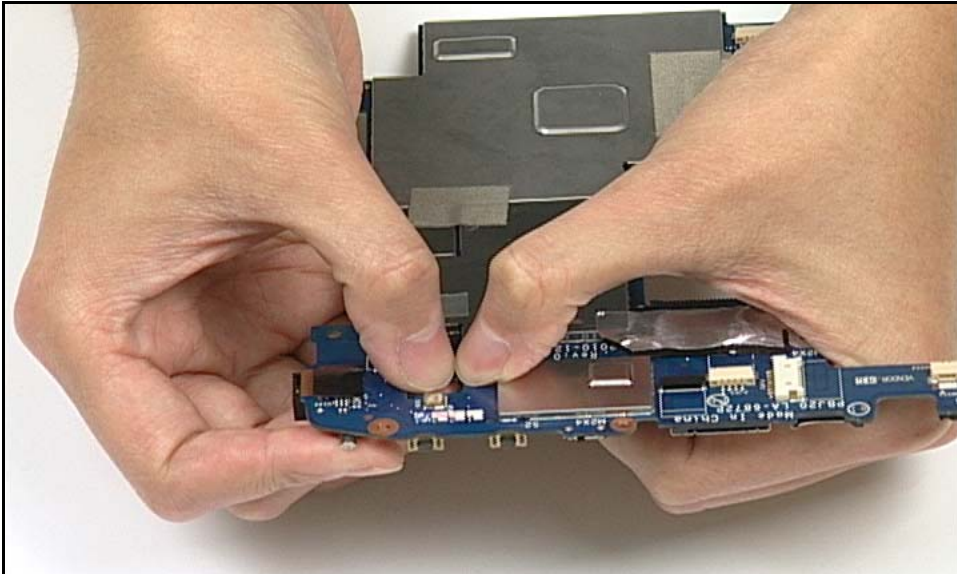


**Figure 3-47. Mainboard Overview**

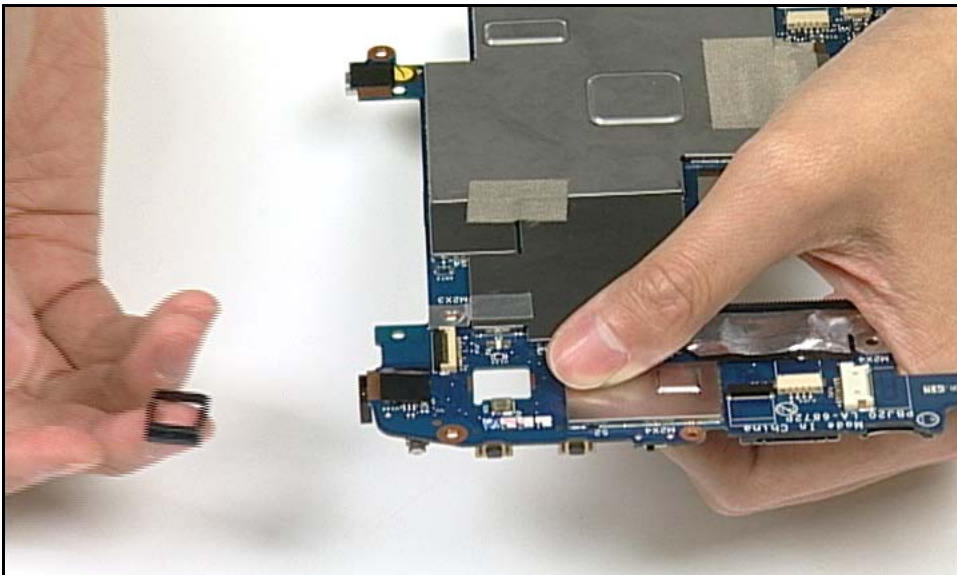
2. Remove rear camera (A) from mainboard.
3. Remove rear camera holder from mainboard by pressing holder through the board. (Figure 3-48 through Figure 3-50)



**Figure 3-48. Removing Rear CCD Holder (1 of 3)**



**Figure 3-49. Removing Rear CCD Holder (2 of 3)**



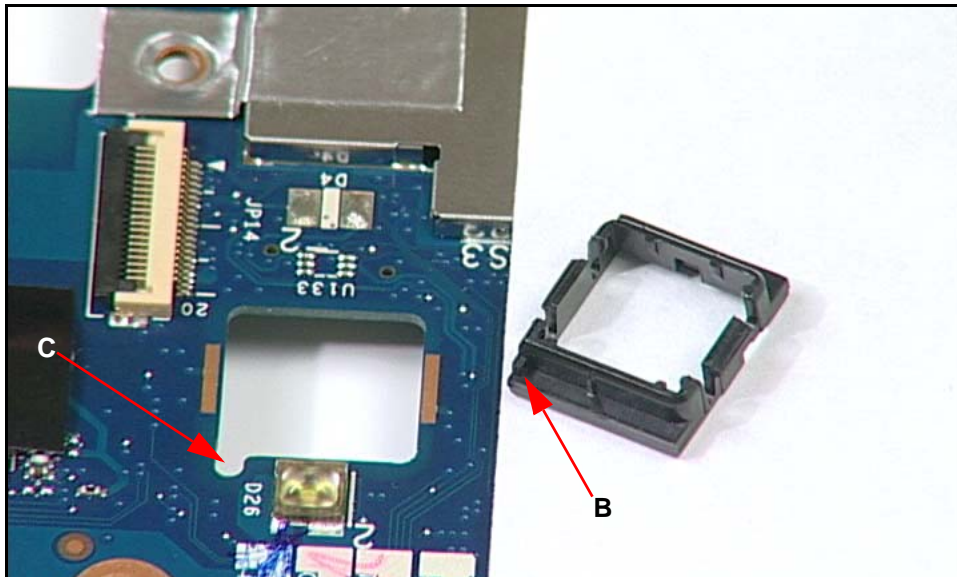
**Figure 3-50. Removing Rear CCD Holder (3 of 3)**



## Rear CCD Installation

---

1. Align rear camera holder guide (B) with mainboard slot (C).(Figure 3-51)



---

**Figure 3-51. Align Rear CCD Holder Guide with Mainboard Slot**

2. Install and secure rear camera holder on mainboard by pressing holder into the opening in the mainboard.(Figure 3-49 through Figure 3-48)
3. Install rear camera (A) on mainboard.(Figure 3-47)
4. Install mainboard.



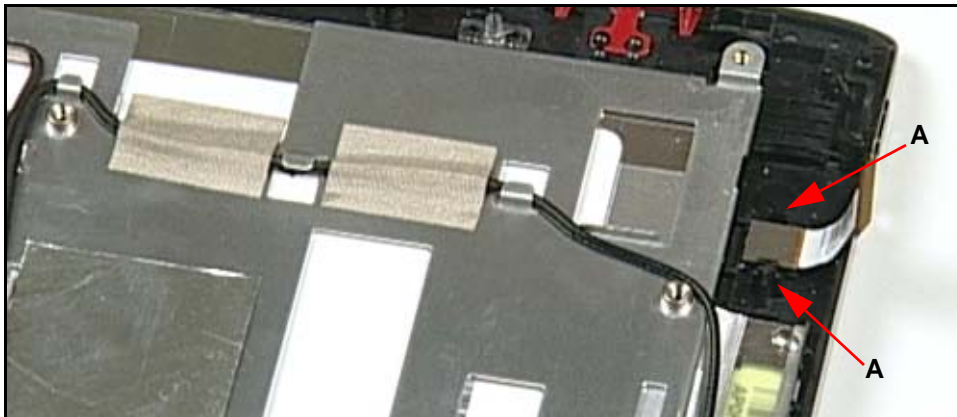
## Front CCD Removal

---

### Prerequisite:

[Mainboard Removal](#)

1. Release bezel locking latches (A).(Figure 3-52)



---

**Figure 3-52. Release Bezel Locking Latches**

2. Remove front camera from bezel.(Figure 3-53)



---

**Figure 3-53. Removing Front CCD**

## Front CCD Installation

---

1. Install and secure front camera in bezel locking latches (A).(Figure 3-52)
2. Install mainboard.

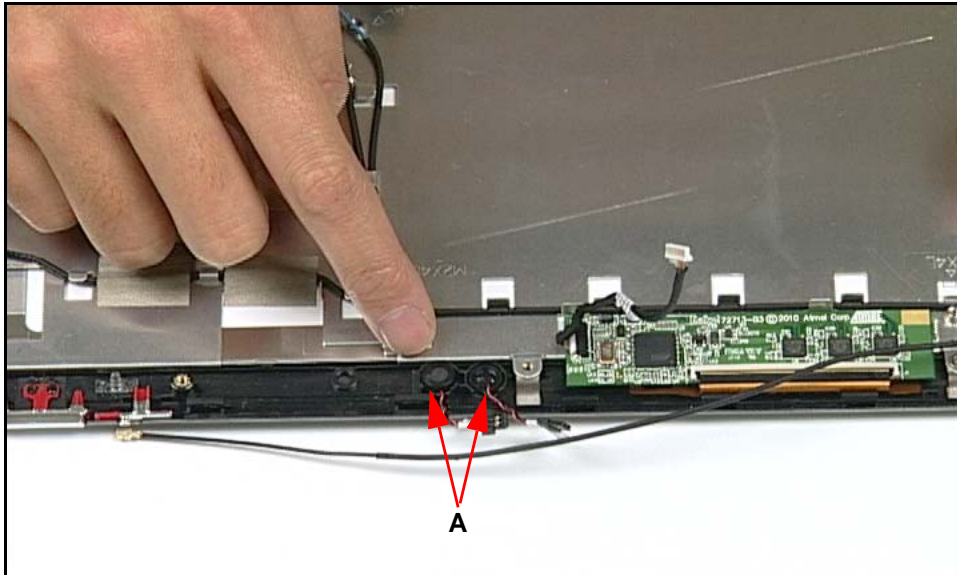
## Two-Piece Microphone Removal

---

### Prerequisite:

[Mainboard Removal](#)

1. Remove two-piece microphone (A) from bezel guides.(Figure 3-54)

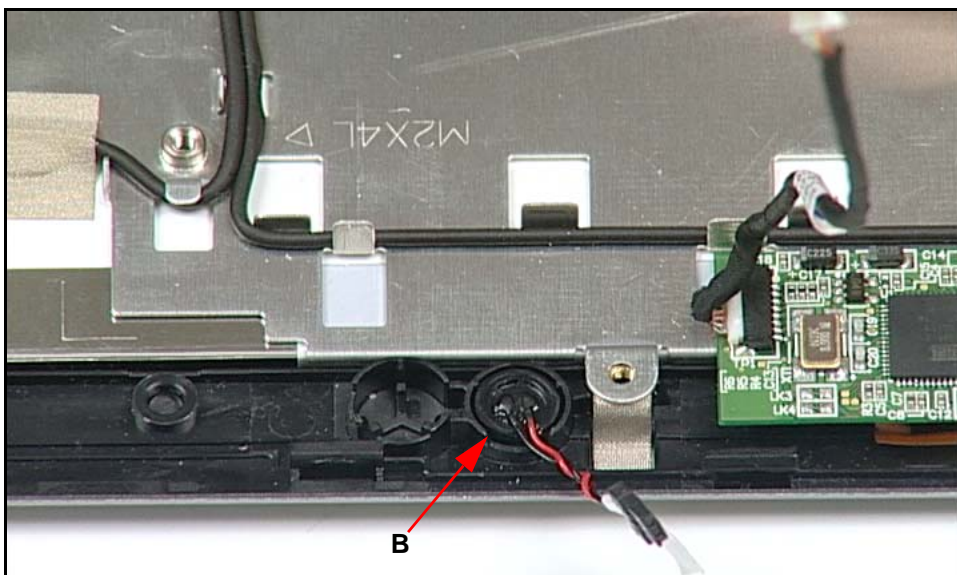


**Figure 3-54. Removing Two-piece Microphone**

## Two-Piece Microphone Installation

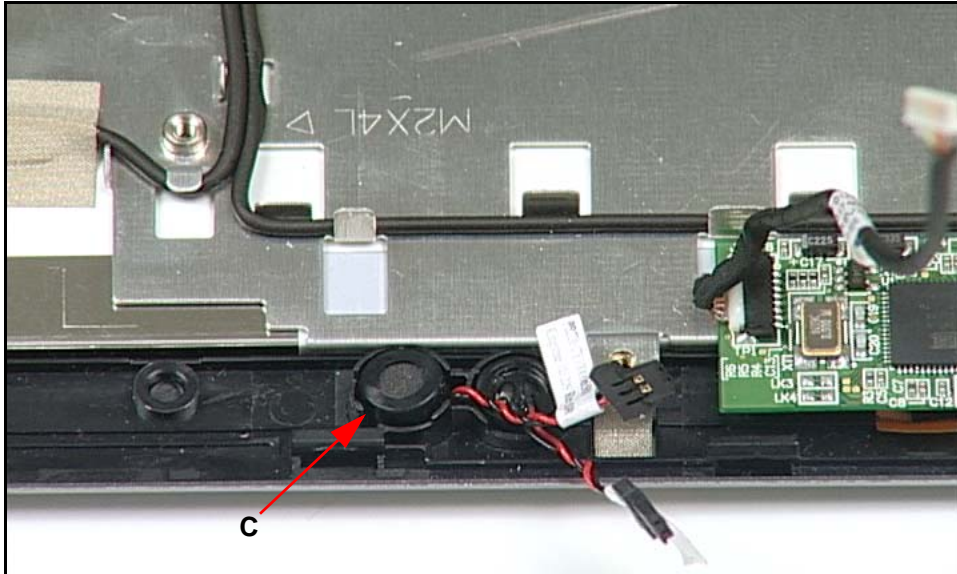
---

1. Install and secure microphone (B) in front microphone guide (closest to control board) facing down.(Figure 3-55)



**Figure 3-55. Installing Two-piece Microphone to Front Guide**

2. Install and secure microphone (C) in rear microphone guide (furthest away from control board) facing up.(Figure 3-56)



**Figure 3-56. Installing Two-piece Microphone to Rear Guide**

3. Install mainboard.

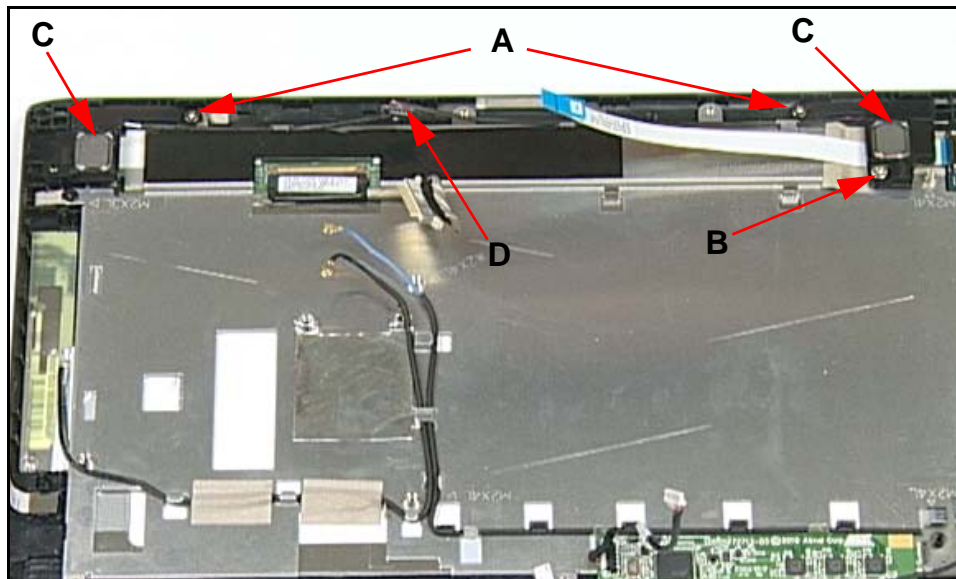
# Speakers Removal

---

## Prerequisite:

[Mainboard Removal](#)

1. Remove screws (A, B) from bezel.(Figure 3-57)



---



**Figure 3-57. LCD Support Plate Overview with Speakers**

2. Remove speakers (C) and speaker cable (D) from bezel.

# Speakers Installation

---

1. Install speakers (C) and speaker cable (D) on bezel. (Figure 3-57)
2. Install and secure screws (A, B) to bezel.
3. Install mainboard.

ID	Size	Quantity	Screw Type
A	M2.0x3.0	2	
B	M2.0x4.0 Ni	1	

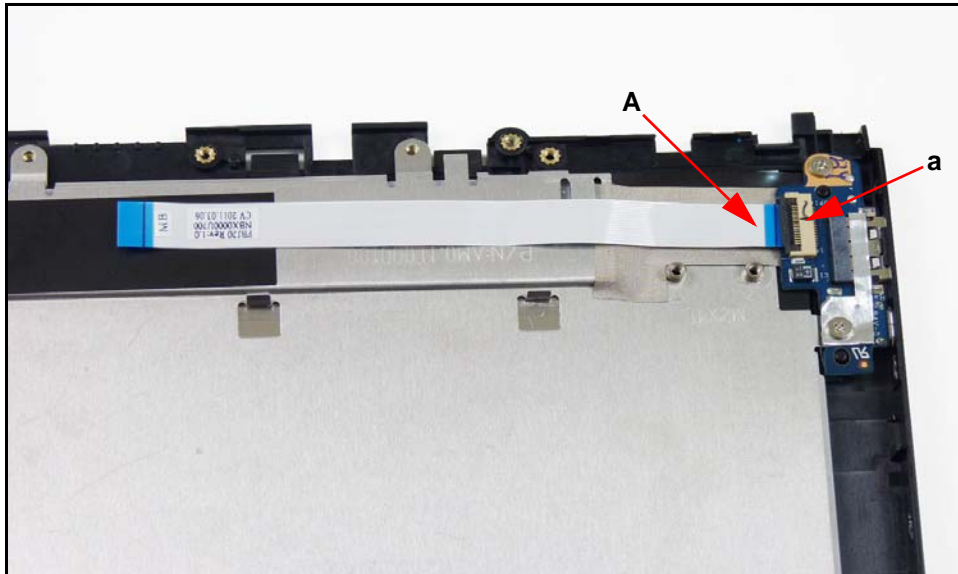
# USB Module Removal

---

## Prerequisite:

[Speakers Removal](#)

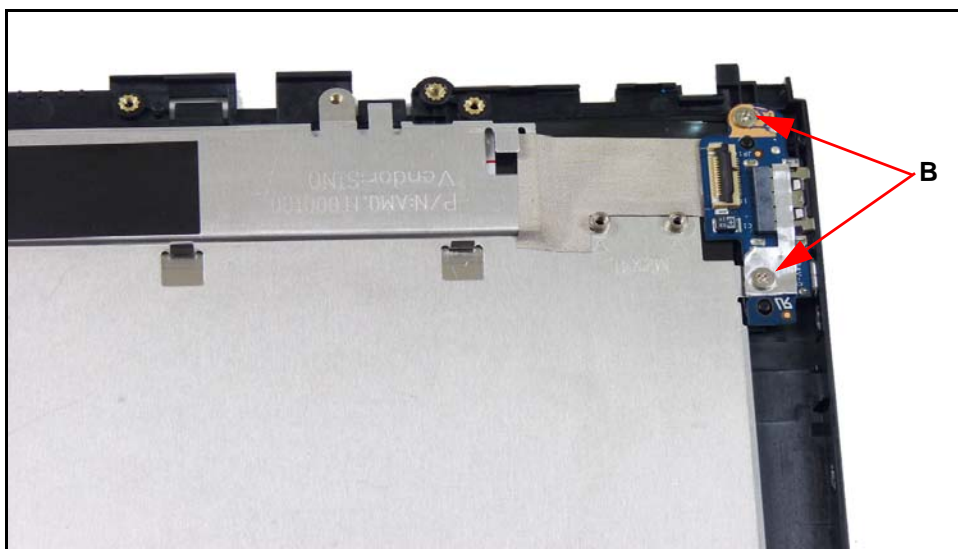
1. Disconnect module FFC (A) from module connector (a). (Figure 3-58)



---

**Figure 3-58. Disconnecting USB FFC**

2. Remove module FFC.
3. Remove screws (B) from bezel. (Figure 3-59)

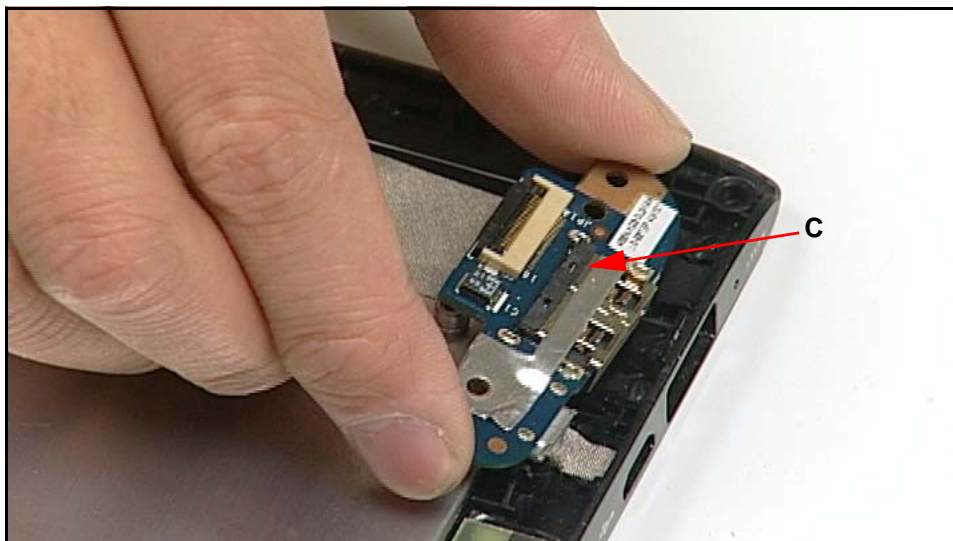


---

**Figure 3-59. Removing USB Module Screws**



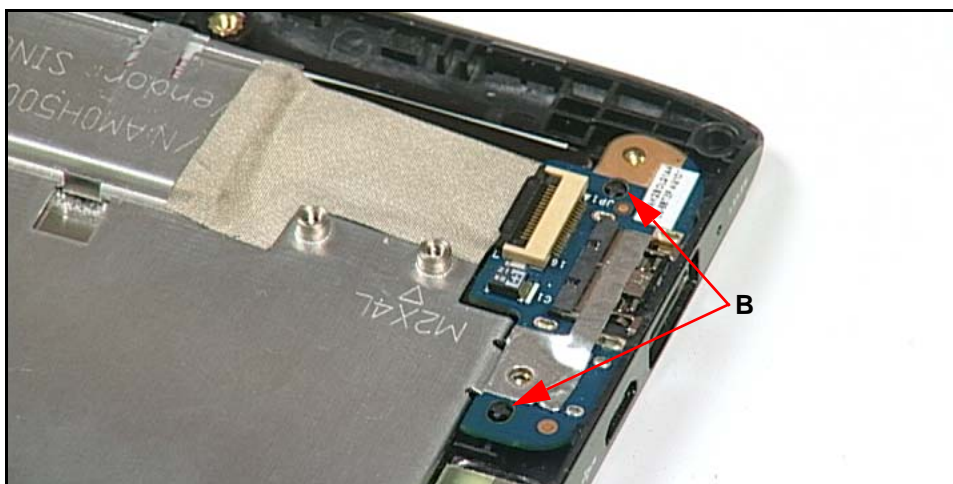
4. Remove module (C). (Figure 3-60)



**Figure 3-60. Removing USB Module**


## USB Module Installation

1. Align module with bezel guides (D). (Figure 3-61)



**Figure 3-61. Aligning USB Module to Bezel Guides**

2. Install module (C) on bezel. (Figure 3-60)
3. Install and secure screws (B) to bezel. (Figure 3-59)
4. Install and connect module FFC (A) to module connector (a). (Figure 3-58)
5. Install speakers.

ID	Size	Quantity	Screw Type
A	M2.0x4.0 Ni	2	

# LCD Support Plate Removal

---

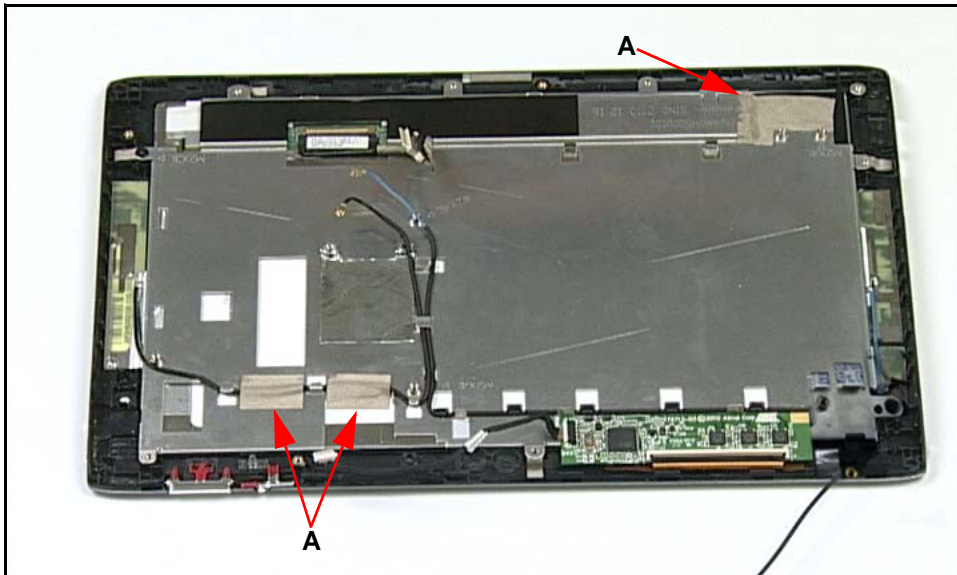
## Prerequisite:

[Speakers Removal](#)

### ⇒ NOTE:

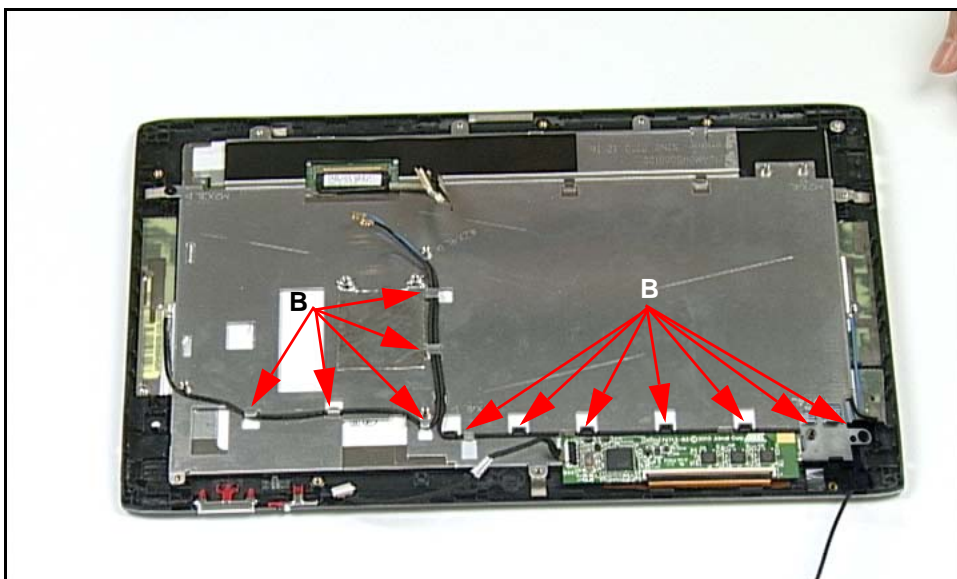
Control board must be shipped with LCD panel for RMA.

1. Remove Mylar tape (A) from LCD support plate. (Figure 3-62)



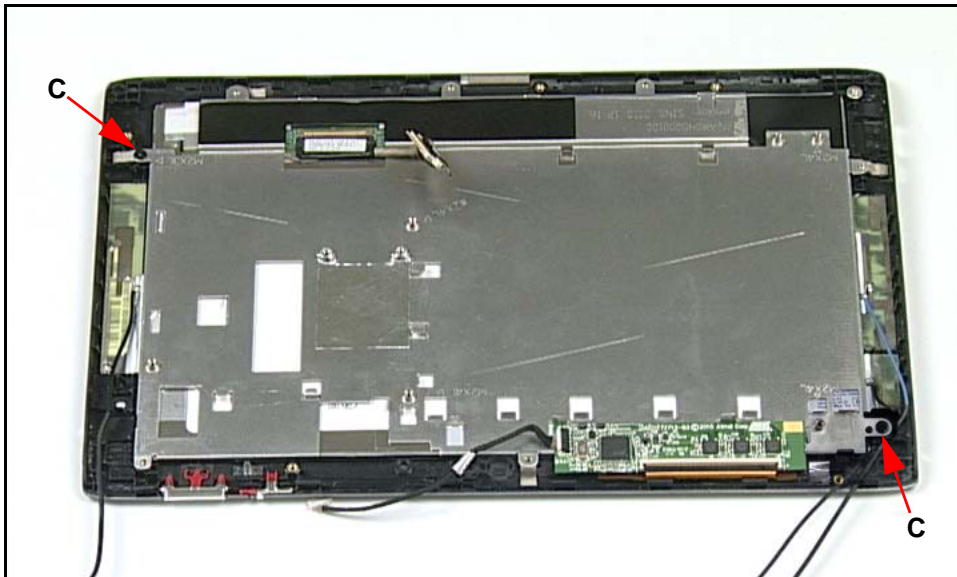
**Figure 3-62. Removing Mylar Tape**

2. Remove antenna cables from LCD support plate guides (B). (Figure 3-63)



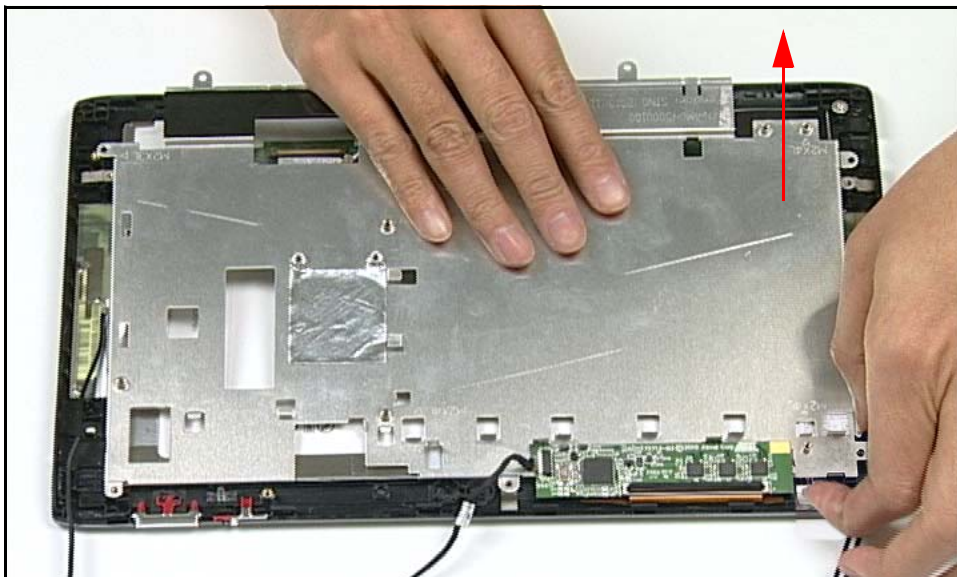
**Figure 3-63. Removing Antenna Cables**

3. Remove screws (C) from bezel. (Figure 3-64)



**Figure 3-64. Removing LCD Support Plate Screws**

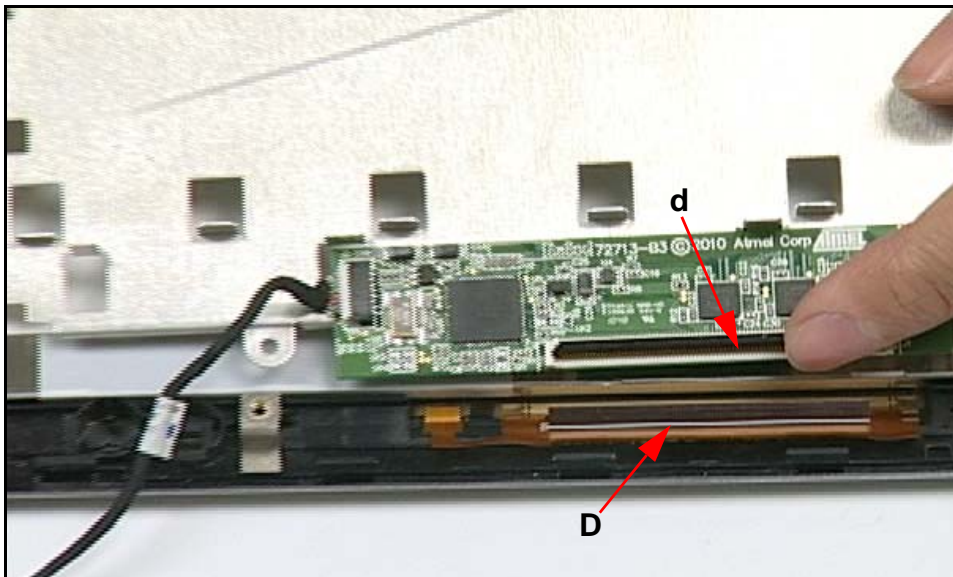
4. Remove LCD support plate. (Figure 3-65)



**Figure 3-65. Removing LCD Support Plate**

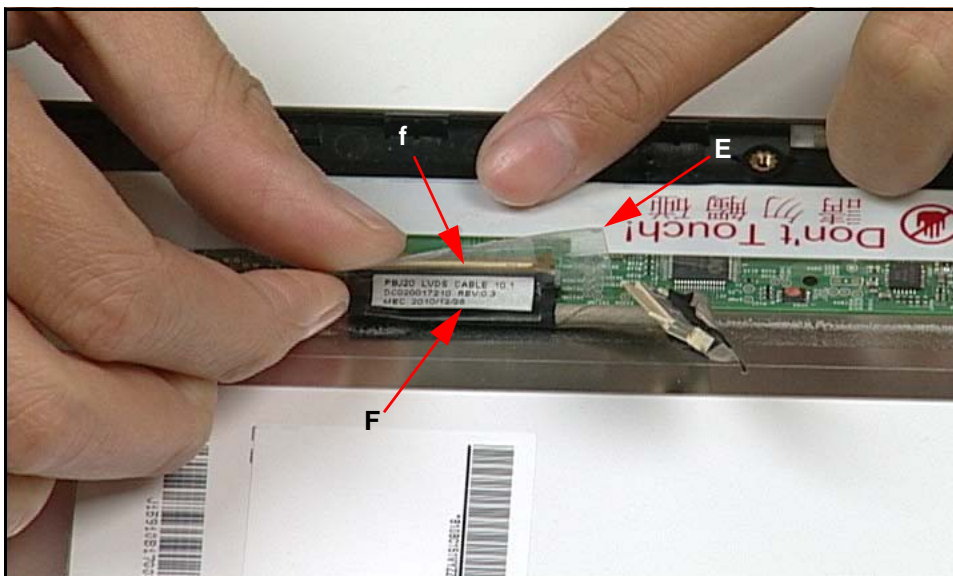


5. Disconnect control board FFC (D) from board connector (d). (Figure 3-66)



**Figure 3-66. Disconnecting Control Board FFC**

6. Remove adhesive tape (G) covering LVDS cable (H) and LCD panel connector (h). (Figure 3-67)




**Figure 3-67. Removing LVDS Adhesive Tape**

7. Disconnect and remove LVDS cable.

## LCD Support Plate Installation

---

1. Connect LVDS cable (F) to LCD panel connector (f). (Figure 3-67)
2. Install and secure adhesive tape (E) covering LVDS cable and LCD panel connector.
3. Connect and secure control board FFC (D) to board connector (d). (Figure 3-66)
4. Install LCD support plate on bezel. (Figure 3-65)
5. Install and secure screws (C) to bezel. (Figure 3-64)
6. Install and secure antenna cables to LCD support plate guides (B). (Figure 3-63)
7. Install and secure Mylar tape (A) to LCD support plate. (Figure 3-62)
8. Install speakers.

ID	Size	Quantity	Screw Type
C	M2.0x3.0	2	

# Control Board Removal

---

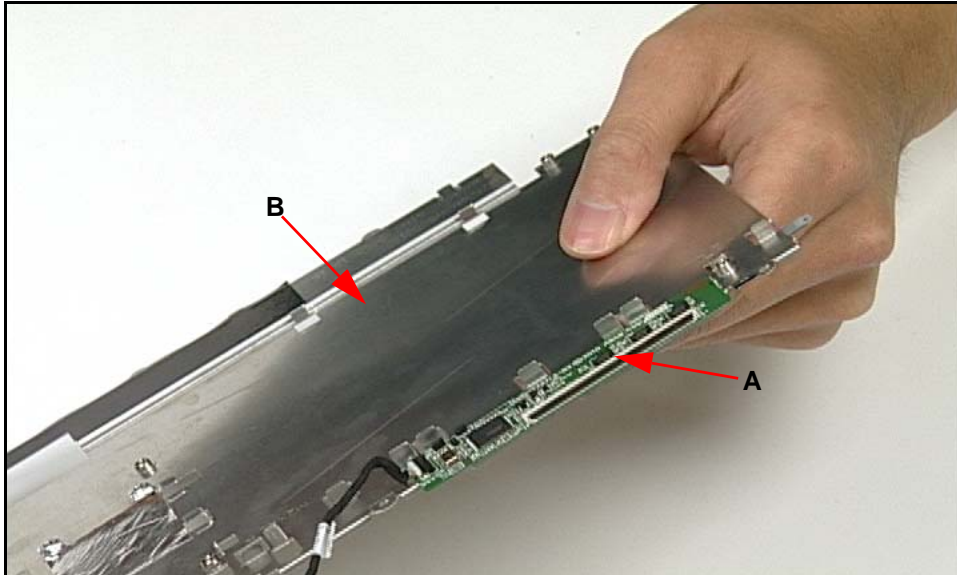
## Prerequisite:

[LCD Support Plate Removal](#)

### ⇒ NOTE:

Control board must be shipped with LCD panel for RMA.

1. Remove control board (A) from LCD support plate (B). (Figure 3-68 and Figure 3-69)



---

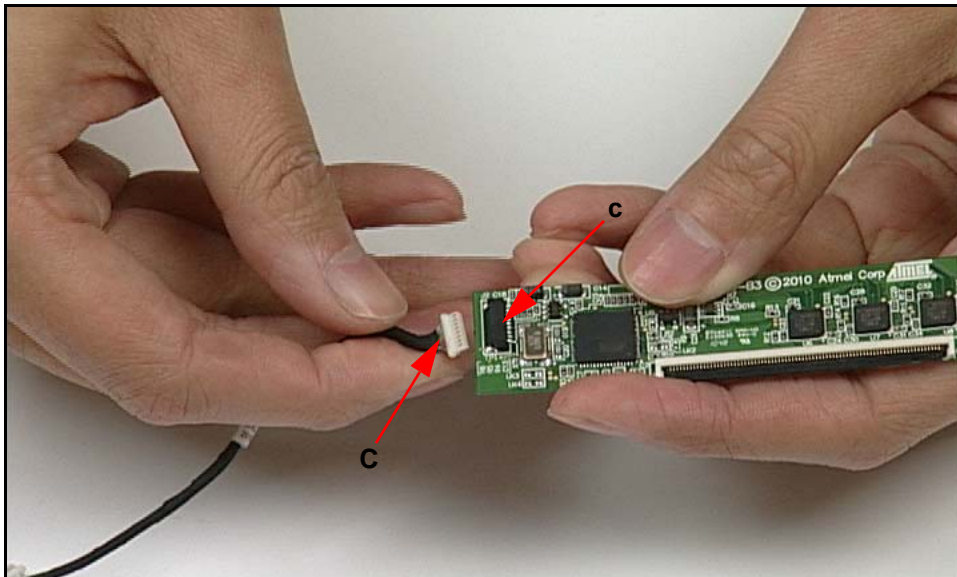
**Figure 3-68. Removing Control Board (1 of 2)**



---

**Figure 3-69. Removing Control Board (2 of 2)**

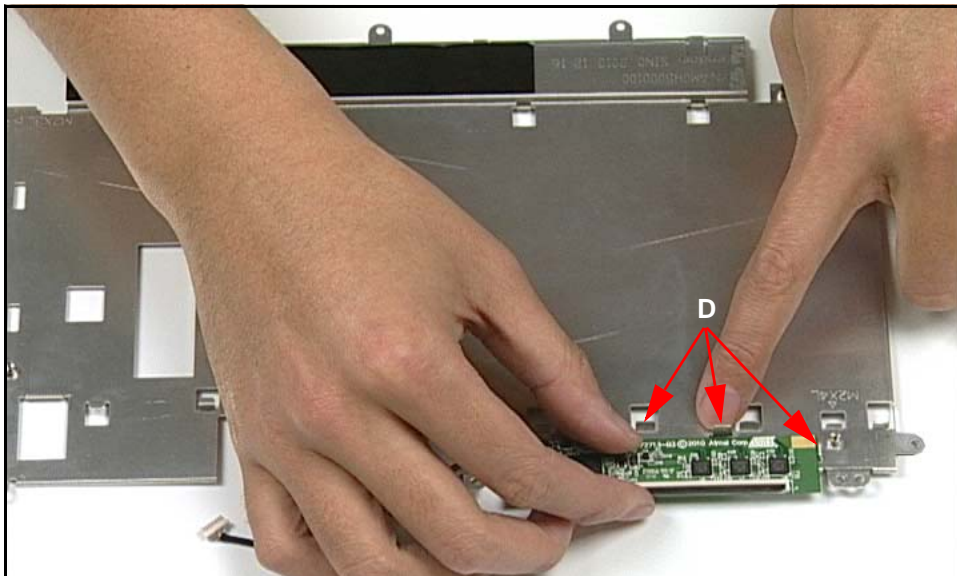
2. Disconnect and remove control board cable (C) from board connector (c). (Figure 3-70)



**Figure 3-70. Removing Control Board Cable**

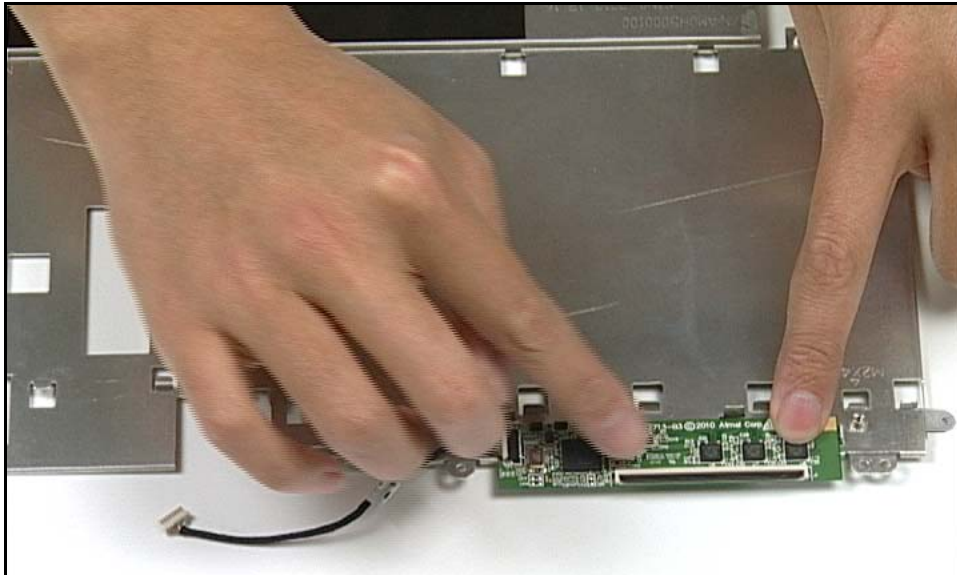
## Control Board Installation

1. Install and connect control board cable (C) to board connector (c). (Figure 3-70)
2. Align control board to LCD support plate guides (D). (Figure 3-71)



**Figure 3-71. Aligning Control Board to LCD Support Plate Guides**

3. Install and secure control board on LCD support plate. (Figure 3-72)



---

**Figure 3-72. Installing Control Board**

4. Install LCD support plate.



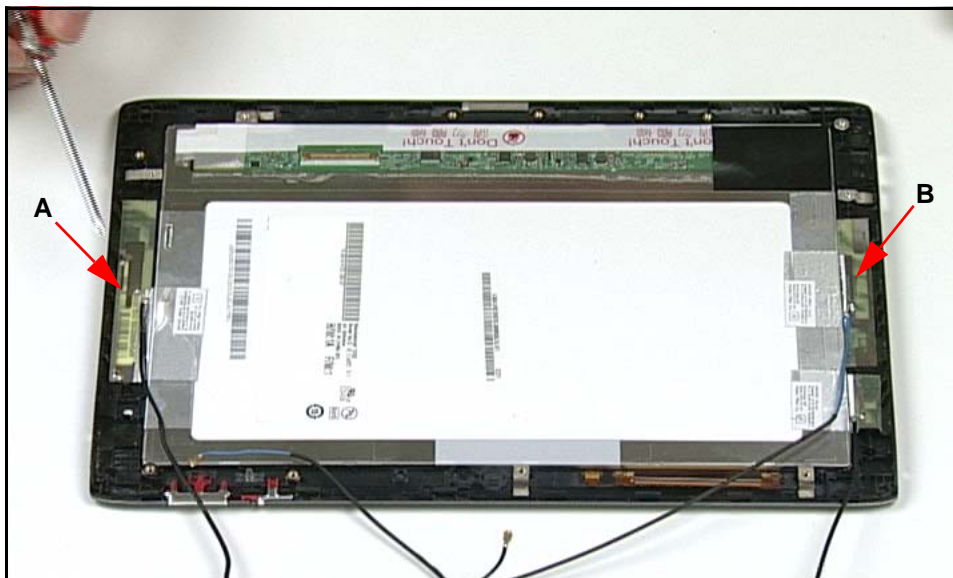
## 3G Antenna Removal

---

### Prerequisite:

[LCD Support Plate Removal](#)

1. Remove main (A, black) and auxiliary (B, blue) antennas from bezel. (Figure 3-73)

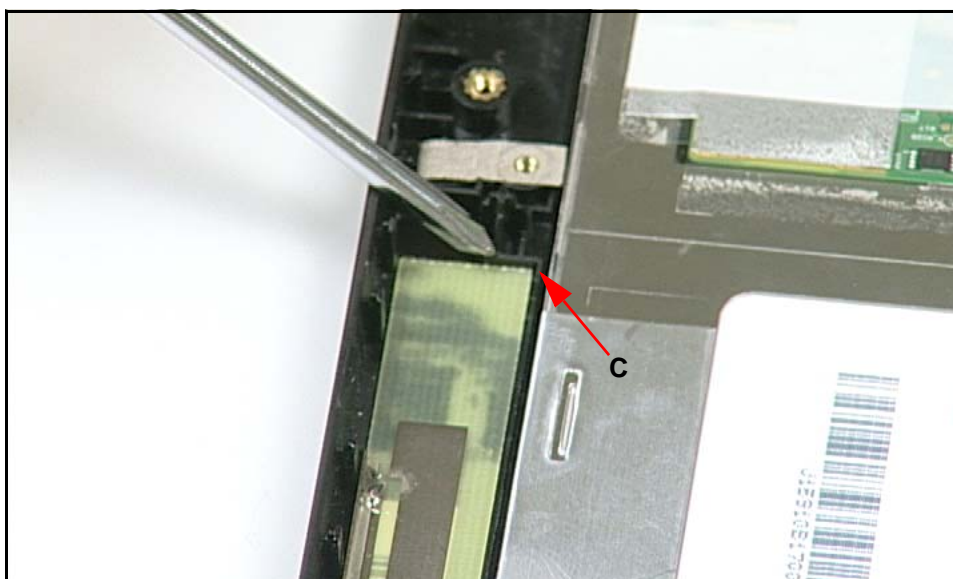


**Figure 3-73. Removing 3G Antennas**

## 3G Antenna Installation

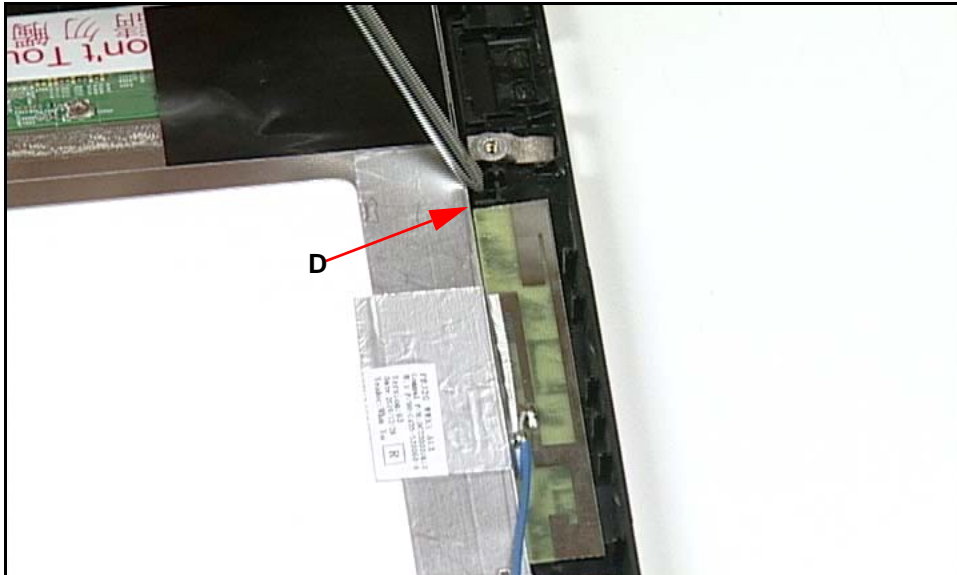
---

1. Align main (black) antenna to bezel guide (C).(Figure 3-74)



**Figure 3-74. Aligning Main 3G Antenna**

2. Align auxiliary (blue) antenna to bezel guide (D).(Figure 3-75)



**Figure 3-75. Aligning Auxiliary 3G Antenna**

3. Install and secure 3G antennas on bezel.
4. Install LCD support plate.

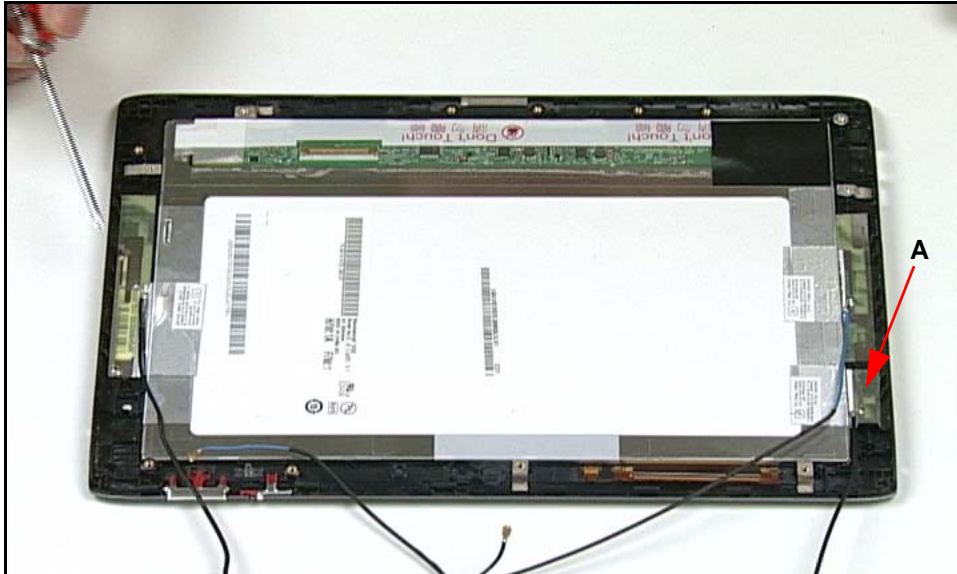
# WLAN Antenna Removal

---

## Prerequisite:

[LCD Support Plate Removal](#)

1. Remove main (black) WLAN antenna (A) from bezel. (Figure 3-76)

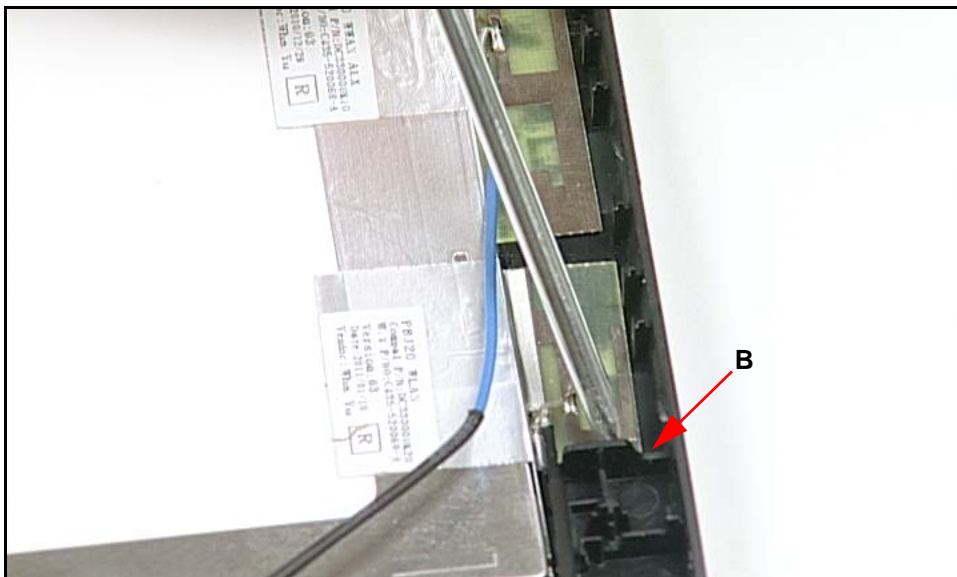


**Figure 3-76. Removing WLAN Antenna**

# WLAN Antenna Installation

---

1. Align main (black) WLAN antenna to bezel guide (B).(Figure 3-77)



**Figure 3-77. Aligning WLAN Antenna**

2. Install and secure WLAN antenna on bezel.
3. Install LCD support plate.





# CHAPTER 4

## Troubleshooting

---

<b>Introduction</b> . . . . .	<b>4-3</b>
<b>General Information</b> . . . . .	<b>4-3</b>
Power On Issues . . . . .	4-4
No Display Issues. . . . .	4-5
LCD Picture Failure . . . . .	4-6
Touch Screen Failure . . . . .	4-7
Internal Speaker Failure. . . . .	4-8
Internal Microphone Failure . . . . .	4-9
USB Failure . . . . .	4-10
Front Camera Failure . . . . .	4-11
Back Camera Failure. . . . .	4-12
P-Sensor Failure . . . . .	4-13
3G Function Failure . . . . .	4-14
Wireless Function Test Failure . . . . .	4-15
GPS Function Test Failure (Wi-Fi SKU). . . . .	4-16
GPS Function Test Failure (3G SKU). . . . .	4-17
Docking Station Test Failure . . . . .	4-18
Other Functions Failure . . . . .	4-19

# Troubleshooting

---

## Introduction

---

This chapter contains information about troubleshooting common problems associated with the notebook.

## General Information

---

The following procedures are a guide for troubleshooting computer problems. The step by step procedures are designed to be performed as described.

⇒ **NOTE:**

The diagnostic tests are intended for Acer products only. Non-Acer products, prototype cards, or modified options can give false errors and invalid system responses.

1. Obtain as much detailed information as possible about the problem.
2. If possible, verify the symptoms by re-creating the failure through diagnostic tests or repeating the operation that led to the problem.
3. Use Table 4-1 with the verified symptom to determine the solution.

**Table 4-1. Verified Symptoms**

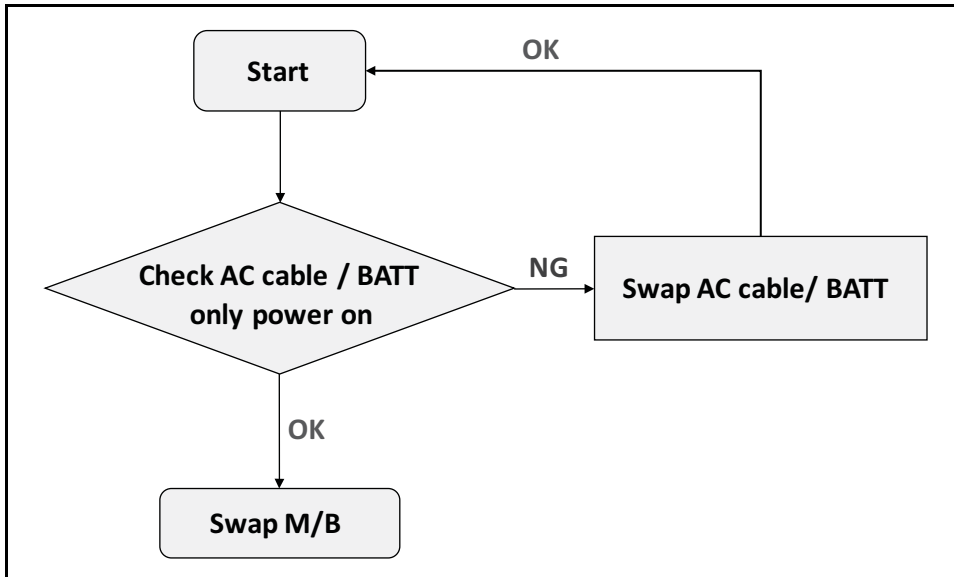
Symptoms (Verified)
<a href="#">Power On Issues</a>
<a href="#">No Display Issues</a>
<a href="#">LCD Picture Failure</a>
<a href="#">Touch Screen Failure</a>
<a href="#">Internal Speaker Failure</a>
<a href="#">Internal Microphone Failure</a>
<a href="#">USB Failure</a>
<a href="#">Front Camera Failure</a>
<a href="#">Back Camera Failure</a>
<a href="#">P-Sensor Failure</a>
<a href="#">3G Function Failure</a>
<a href="#">Wireless Function Test Failure</a>
<a href="#">GPS Function Test Failure (Wi-Fi SKU)</a>
<a href="#">GPS Function Test Failure (3G SKU)</a>
<a href="#">Docking Station Test Failure</a>
<a href="#">Other Functions Failure</a>

4. If the Issue is still not resolved, refer to [Online Support Information](#).

# Power On Issues

---

If the system doesn't power on, perform the following:



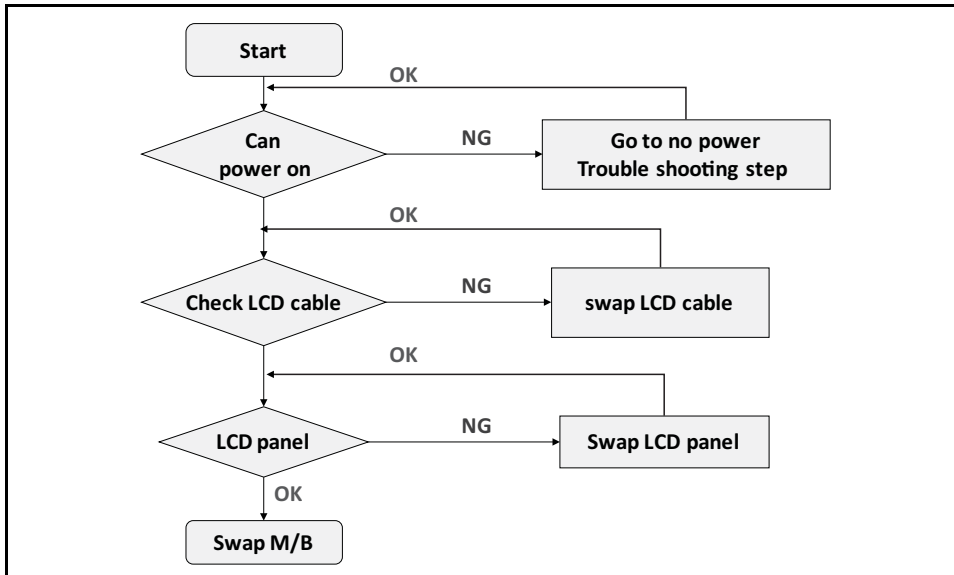
---

Figure 4-1. Power On Issues

# No Display Issues

---

If the system doesn't display, perform the following:



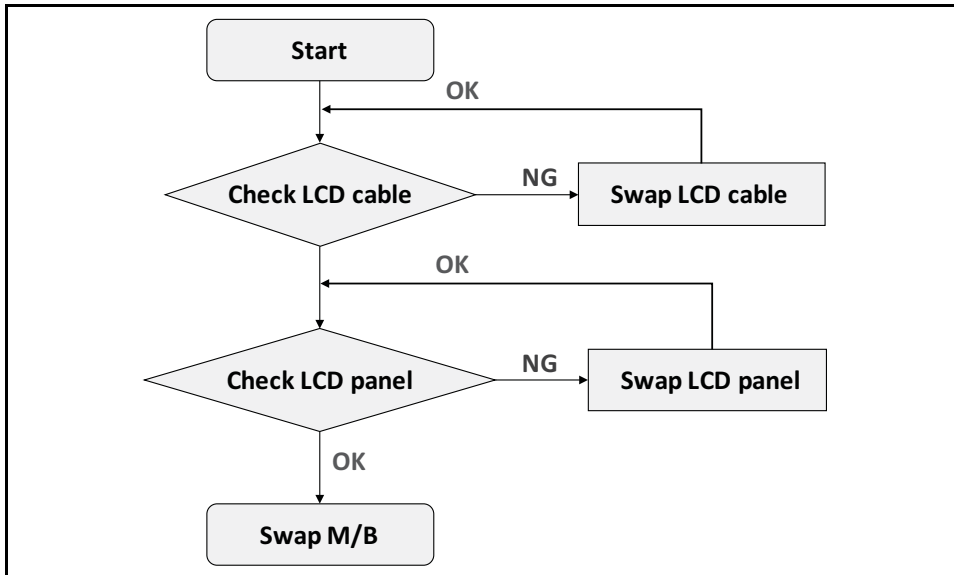
---

Figure 4-2. No Display Issues

# LCD Picture Failure

---

If the LCD picture fails, perform the following:



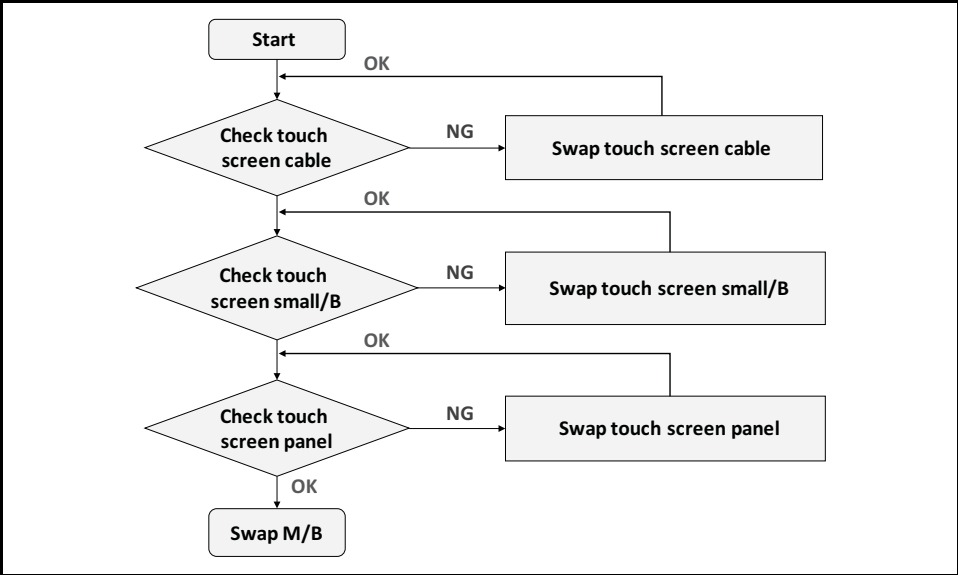
---

Figure 4-3. LCD Picture Failure

# Touch Screen Failure

---

If the touch screen fails, perform the following:



---

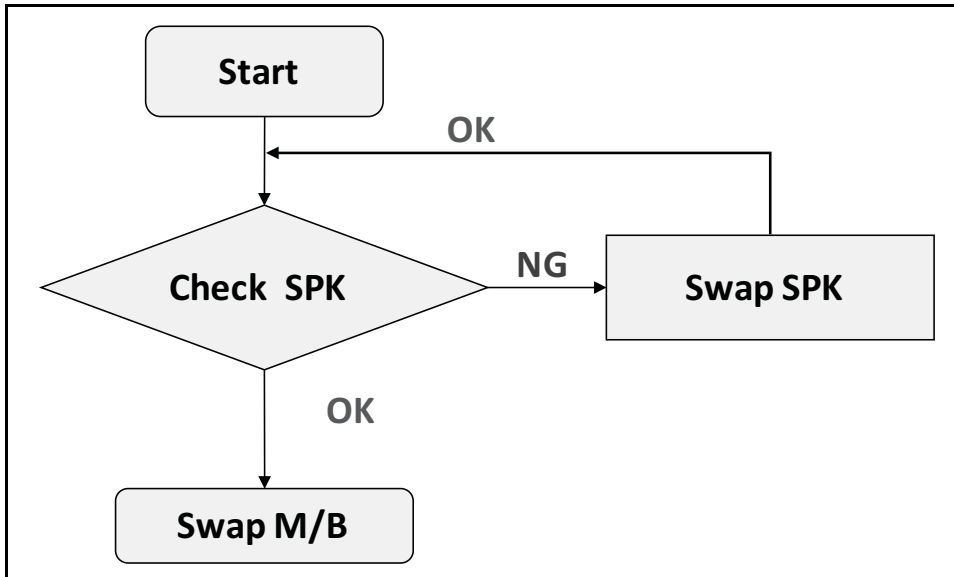
Figure 4-4. Touch Screen Failure



# Internal Speaker Failure

---

If the internal speakers fail, perform the following:



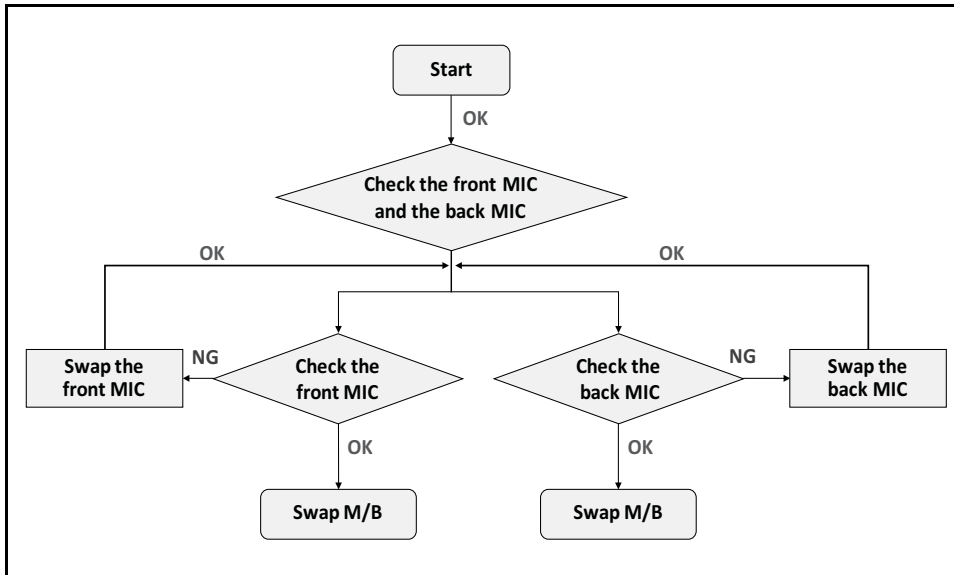
---

Figure 4-5. Internal Speaker Failure

# Internal Microphone Failure

---

If the internal microphone fails, perform the following:



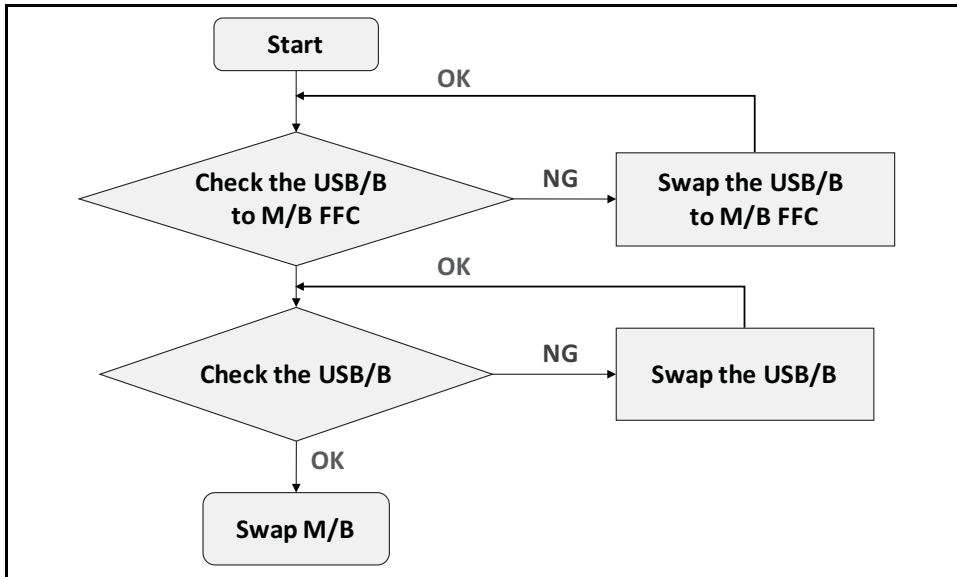
---

**Figure 4-6. Internal Microphone Failure**

# USB Failure

---

If the USB fails, perform the following:



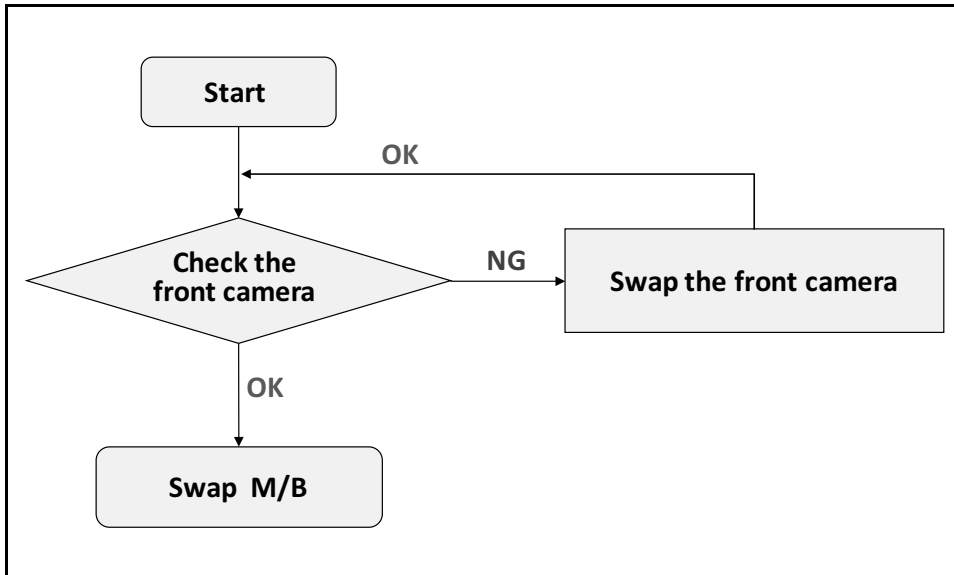
---

Figure 4-7. USB Failure

# Front Camera Failure

---

If the front camera fails, perform the following:



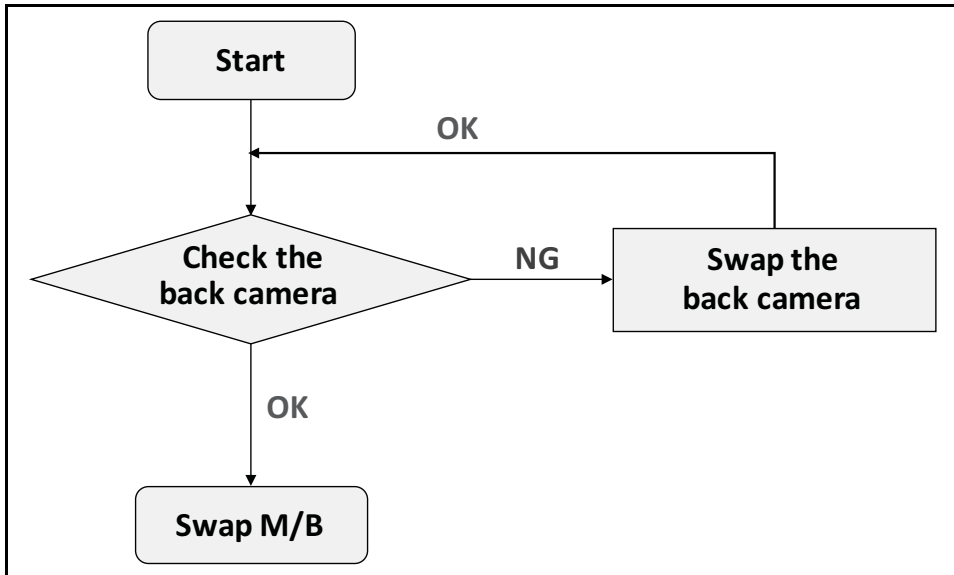
---

**Figure 4-8. Front Camera Failure**

# Back Camera Failure

---

If the back camera fails, perform the following:



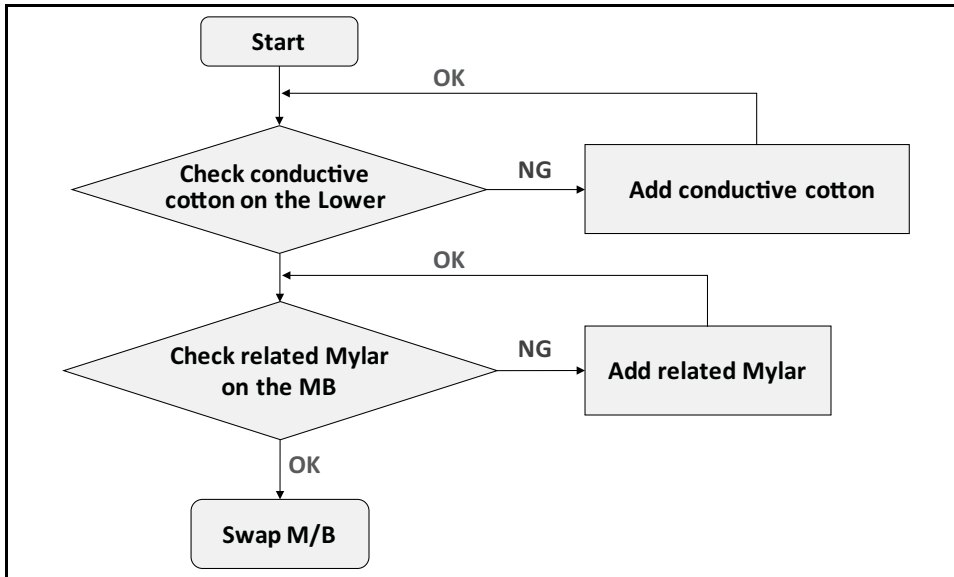
---

Figure 4-9. Back Camera Failure

# P-Sensor Failure

---

If the P-sensor fails, perform the following:



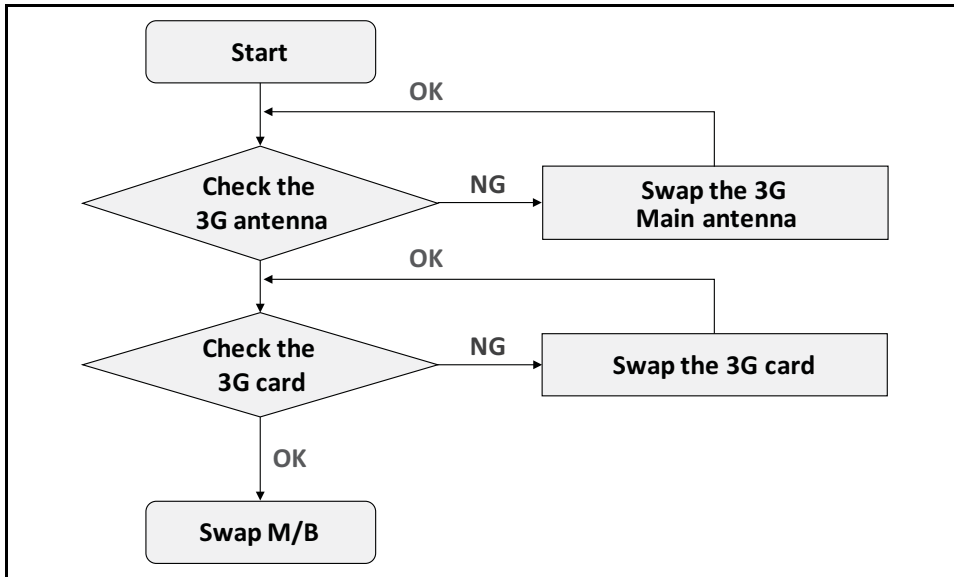
---

**Figure 4-10. P-Sensor Failure**

# 3G Function Failure

---

If the 3G function fails, perform the following:



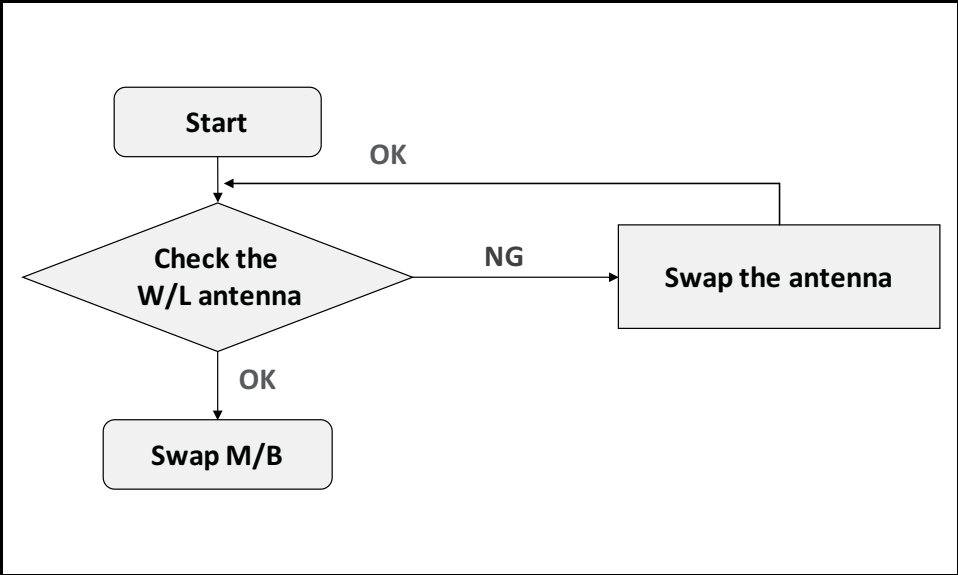
---

Figure 4-11. 3G Function Failure

# Wireless Function Test Failure

---

If the wireless function fails, perform the following:



---

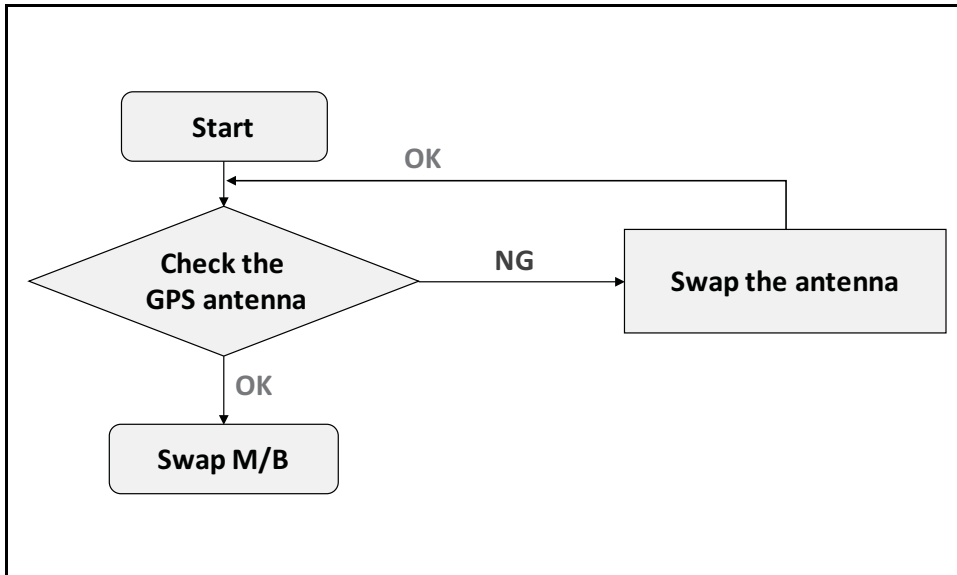
Figure 4-12. Wireless Function Failure



## GPS Function Test Failure (Wi-Fi SKU)

---

If the GPS function test fails, perform the following:



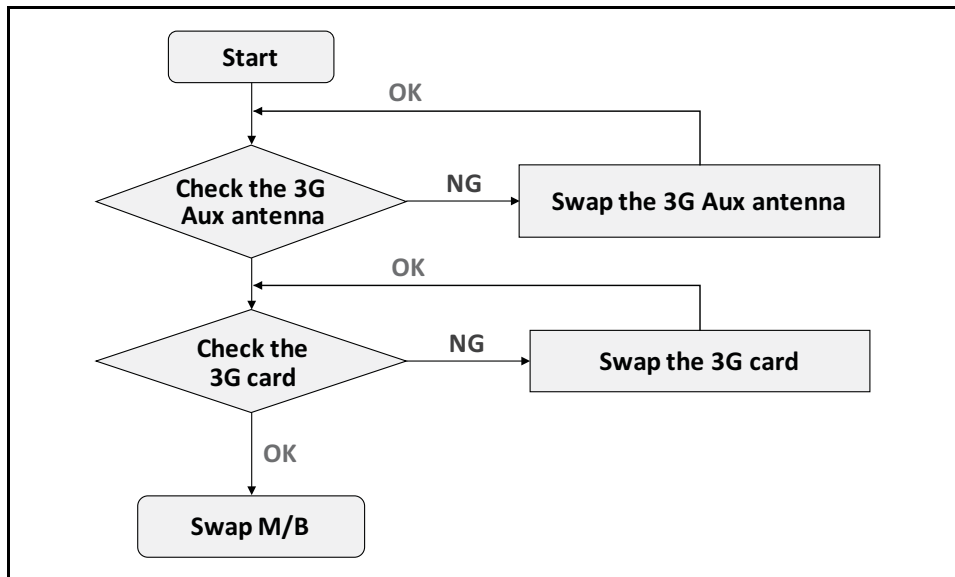
---

**Figure 4-13. GPS Function Test Failure**

## GPS Function Test Failure (3G SKU)

---

If the GPS function test fails, perform the following:



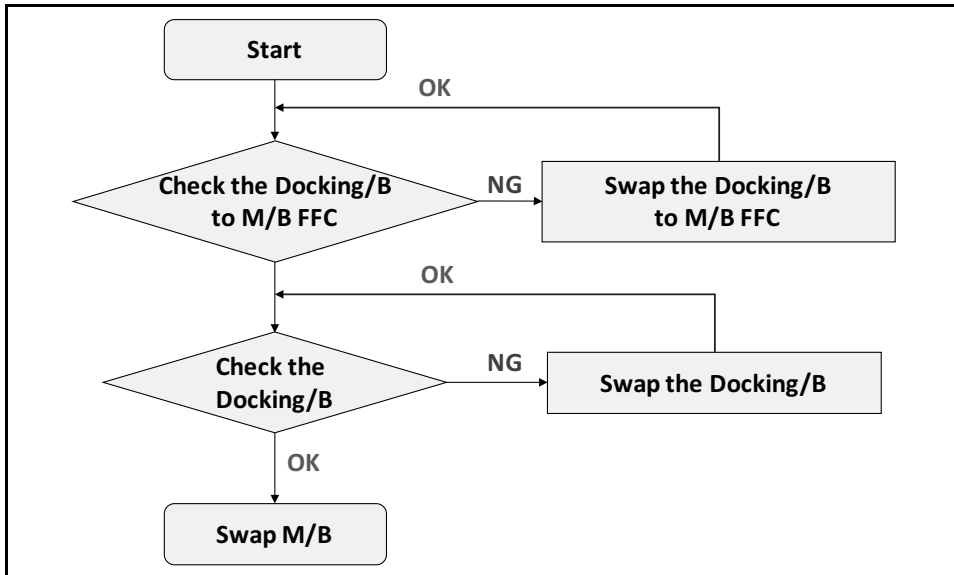
---

Figure 4-14. GPS Function Test Failure

# Docking Station Test Failure

---

If the docking station test fails, perform the following:



---

Figure 4-15. Docking Station Test Failure

## Other Functions Failure

---

1. Check component connection to mainboard.
2. To test for mainboard fault, swap mainboard.



# CHAPTER 5

## Jumper and Connector Locations

**Mainboard Top . . . . .5-3**  
**Mainboard Bottom . . . . .5-4**

# Jumper and Connector Locations

## Mainboard Top

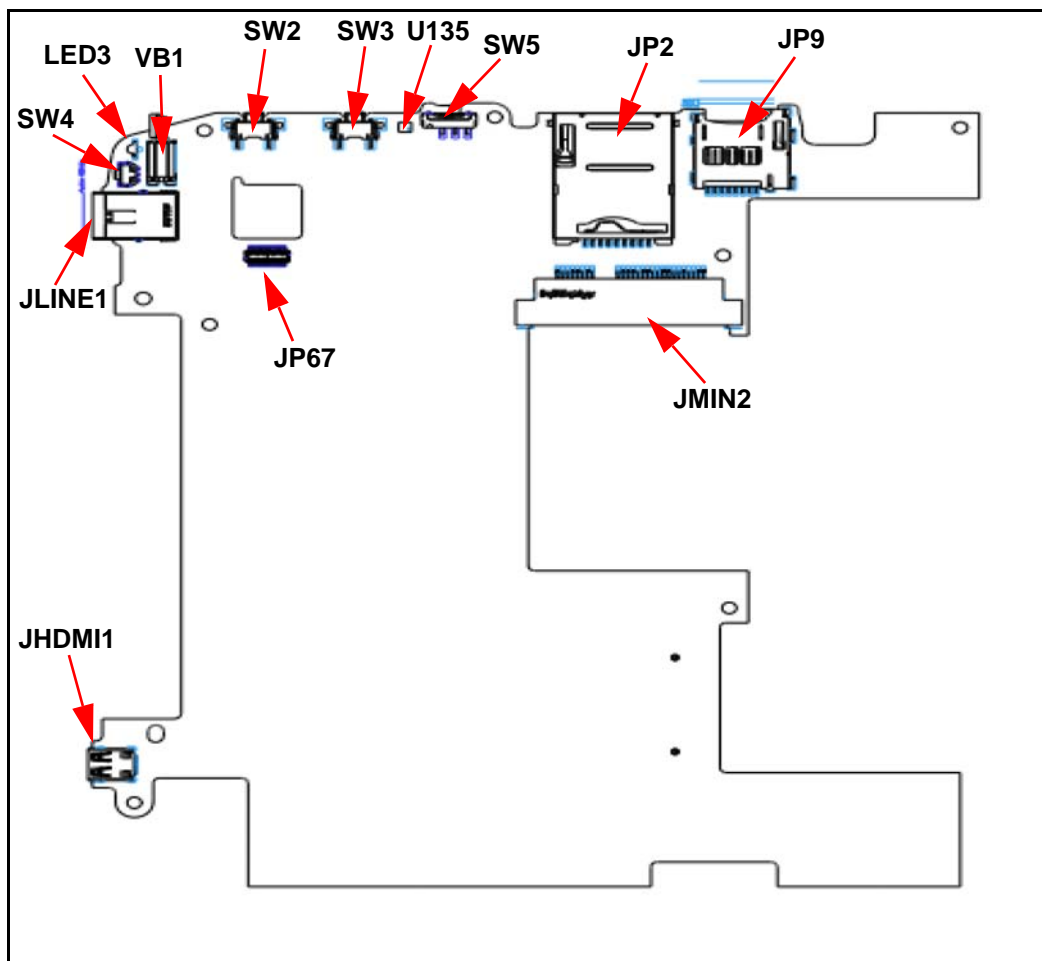


Figure 5-1. Mainboard Top

Table 5-1. Mainboard Top

Item	Description	Item	Description
LED3	Power / Battery LED	JP9	Micro SD connector
VB1	Vibrator	JMIN2	3G connector
SW2, SW3	Volume key	SW4	Power button
U135	Light sensor	JLINE1	Audio Jack
SW5	Lock key	JHDMI1	HDMI connector
JP2	SIM connector	JP67	5M camera connector



# Mainboard Bottom

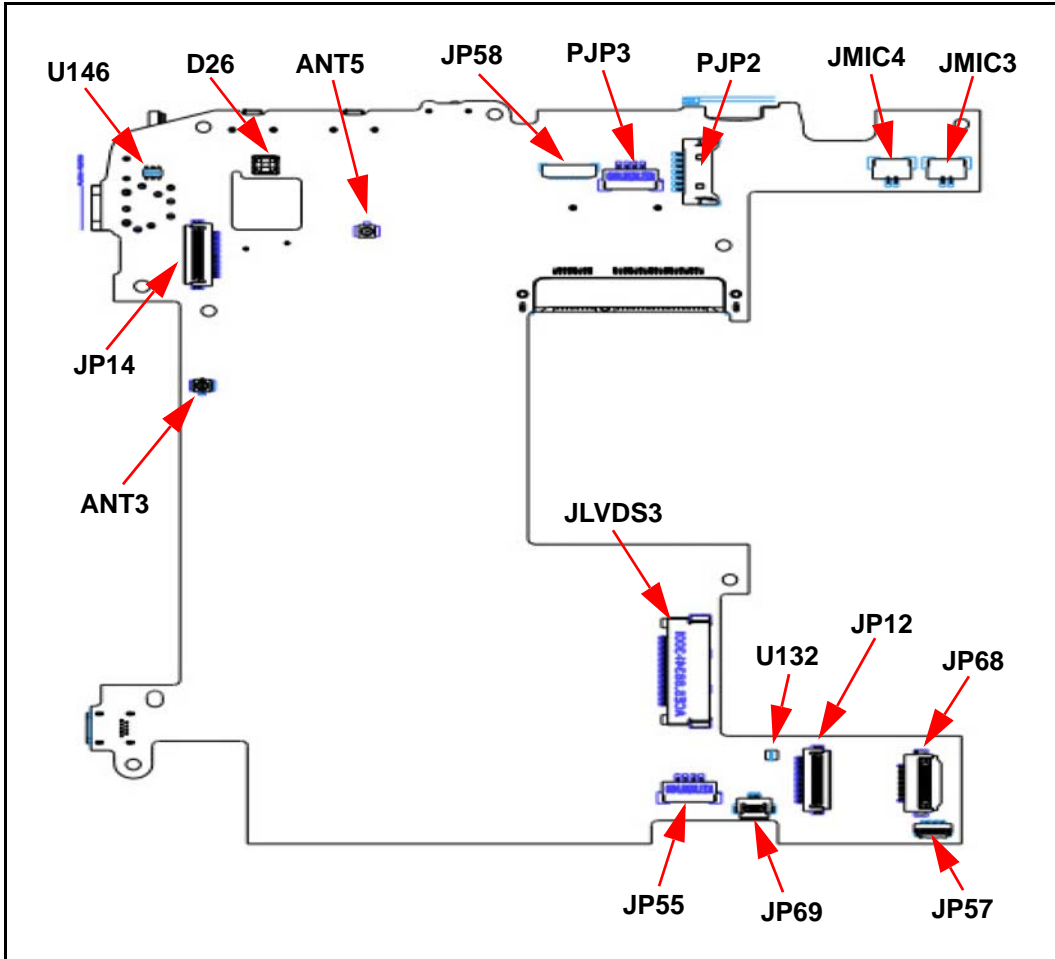


Figure 5-2. Mainboard Bottom

Table 5-2. Mainboard Bottom

Item	Description	Item	Description
U146	P-sensor	JP55	Speaker connector
D26	Flash LED	U132	E-compass
ANT5	WIFI Antenna	JP12	Docking connector
JP58	Touch panel connector	JP68	IO connector
PJP3	DC-IN connector	JP57	Update EC firmware connector
PJP2	Battery connector	JP69	Debug connector
JMIC4, JMIC3	MIC connector	ANT3	GPS Antenna
JLVDS3	Panel connector	JP14	2M camera connector

# CHAPTER 6

## Field Replaceable Unit List

---

<b>Exploded Diagrams</b> .....	<b>6-4</b>
Main Assembly .....	6-4
LCD Exploded Diagram .....	6-8
<b>FRU List</b> .....	<b>6-9</b>
<b>Screw List</b> .....	<b>6-12</b>

# FRU List

---

This chapter provides users with a FRU (Field Replaceable Unit) listing in global configurations for the Gateway TP-A60W/ TP-A60G. Refer to this chapter whenever ordering for parts to repair or for RMA (Return Merchandise Authorization).

**⇒ NOTE:**

When ordering FRU parts, check the most up-to-date information available on the regional web or channel. Part number changes will not be noted on the printed Service Guide. For Acer Authorized Service Providers, the Acer office may have a different part number code from those given in the FRU list of this printed Service Guide. Users **MUST** use the local FRU list provided by the regional Acer office to order FRU parts for repair and service of customer machines.

**⇒ NOTE:**

To scrap or to return the defective parts, users should follow the local government ordinance or regulations on how to dispose it properly, or follow the rules set by the regional Acer office on how to return it.

# Exploded Diagrams

## Main Assembly

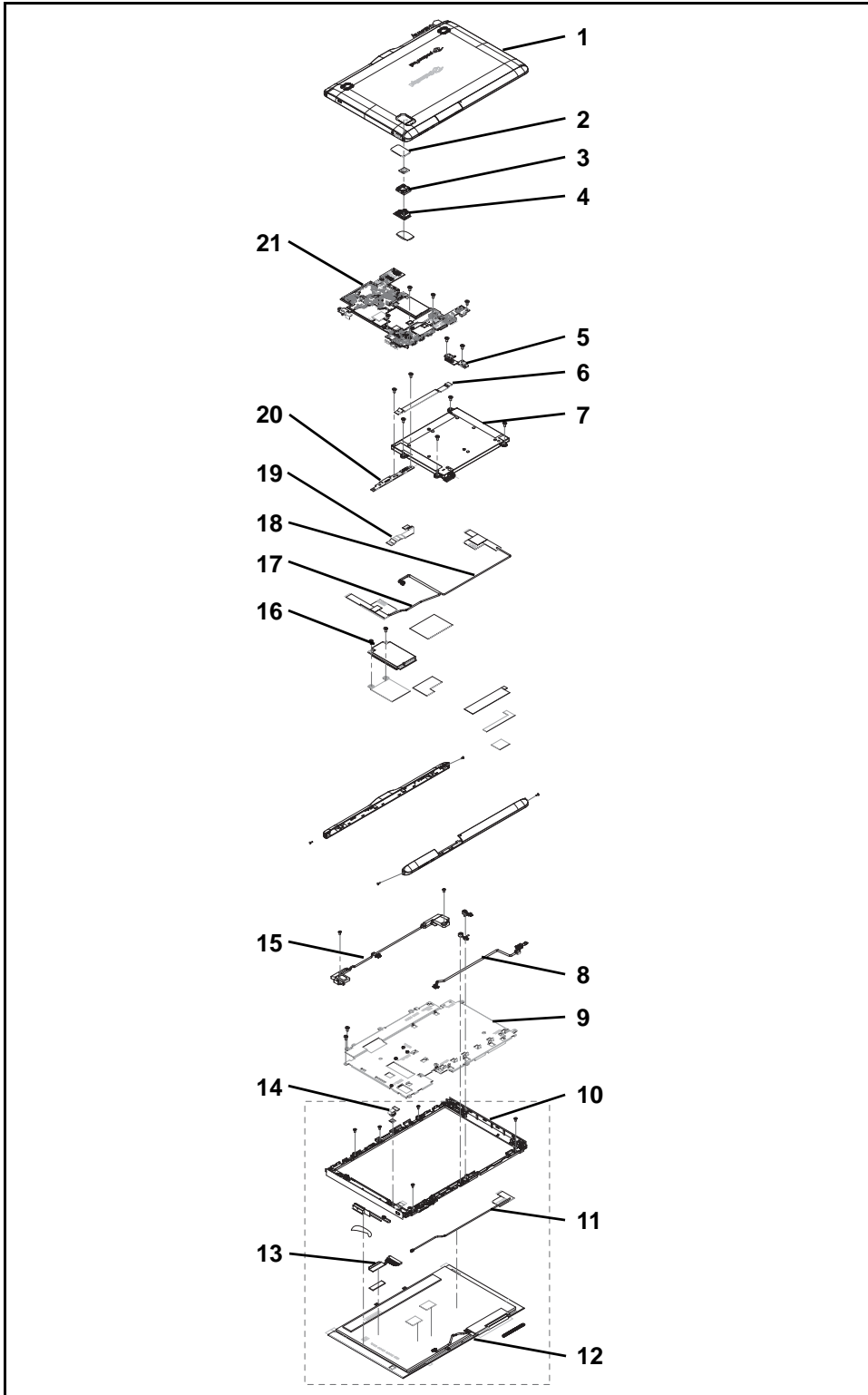


Figure 6-1. Main Assembly W/3G Exploded Diagram

**Table 6-1. Main Assembly W/3G Exploded Diagram**

<b>No.</b>	<b>Description</b>	<b>P/N</b>
1	LOWER CASE INCL. CAMERA GLASS FOR 3G	60.H6002.001
2	CAMERA GLASS FOR 5M CAMERA	60.H6002.002
3	CAMERA HOLDER FOR 5M CAMERA	42.H6002.001
4	CAMERA 5M	57.H6002.002
5	USB BOARD	55.H6002.002
6	USB BOARD FFC	50.H6002.003
7	BATTERY	BT.00207.001
8	DC-IN CABLE	50.H6002.001
9	LCD SUPPORT PLATE FOR 3G	33.H6M02.001
10	LCD BEZEL	60.H6002.004
11	ANTENNA WLAN	50.H6002.005
12	ASSY LCD TOUCH MODULE 10.1 FOR WIFI	6M.H6002.001
13	LVDS CABLE	50.H6002.009
14	CAMERA 2M	57.H6002.001
15	SPEAKER L+R	23.H6002.002
16	(3G MODULE)	LC.21300.056
17	ANTENNA 3G-AUX	50.H6002.007
18	ANTENNA 3G-MAIN	50.H6002.006
19	DOCKING BOARD FFC	50.H6002.002
20	DOCKING BOARD	55.H6002.001
21	MAINBOARD	MB.70500.041

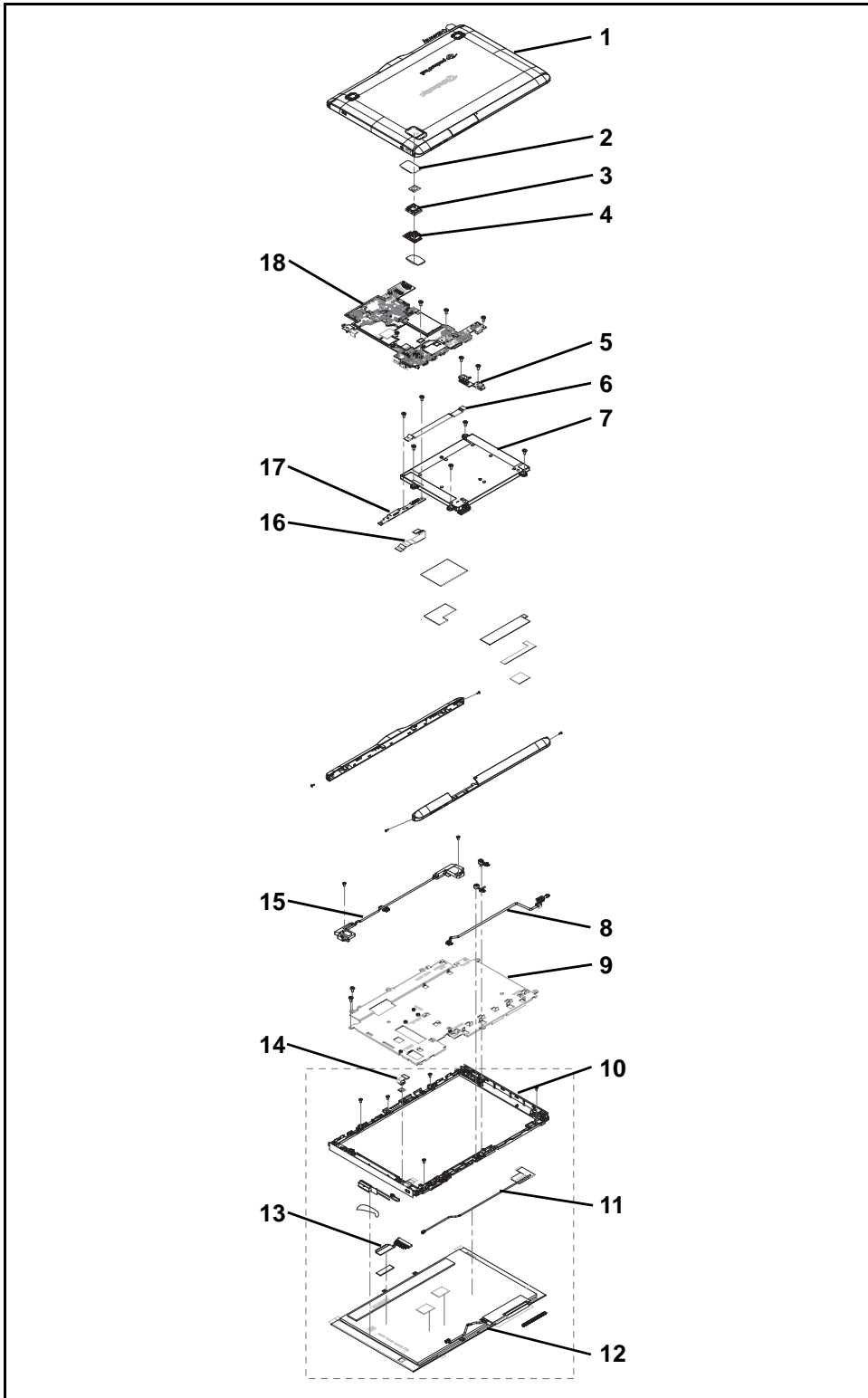


Figure 6-2. Main Assembly W/O 3G Exploded Diagram

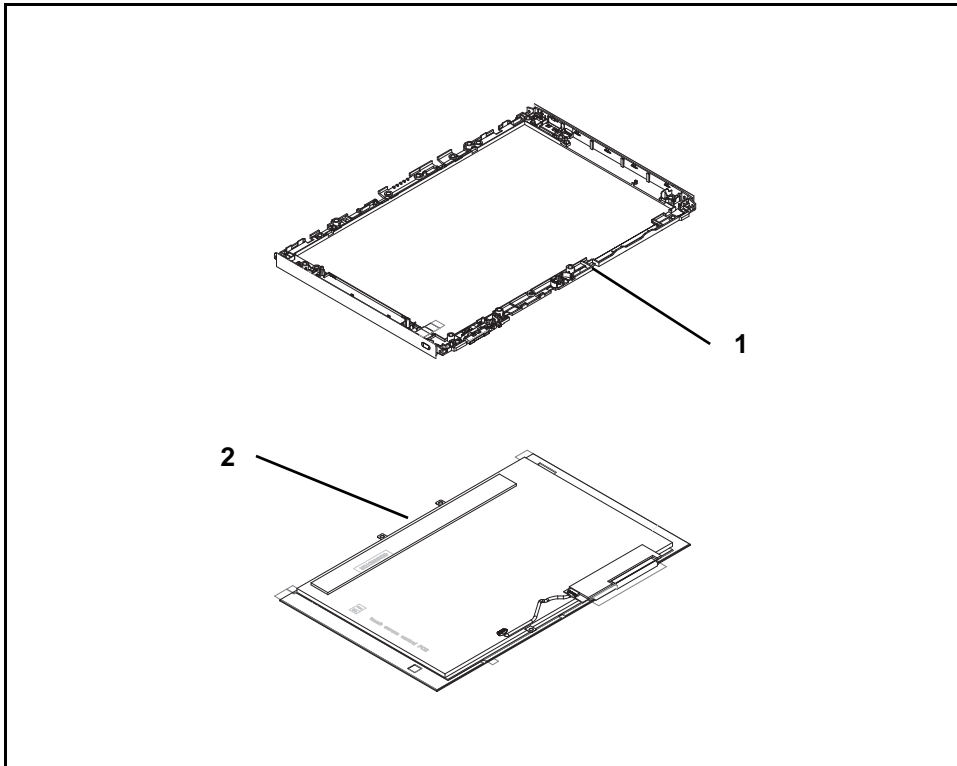
**Table 6-2. Main Assembly W/O 3G Exploded Diagram**

<b>No.</b>	<b>Description</b>	<b>P/N</b>
1	LOWER CASE INCL. CAMERA GLASS W/O 3G	60.H6002.001
2	CAMERA GLASS FOR 5M CAMERA	60.H6002.002
3	CAMERA HOLDER FOR 5M CAMERA	42.H6002.001
4	CAMERA 5M	57.H6002.002
5	USB BOARD	55.H6002.002
6	USB BOARD FFC	50.H6002.003
7	BATTERY	BT.00207.001
8	DC-IN CABLE	50.H6002.001
9	LCD SUPPORT PLATE FOR W/O 3G	33.H6M02.001
10	LCD BEZEL	60.H6002.004
11	ANTENNA WLAN	50.H6002.005
12	ASSY LCD TOUCH MODULE 10.1 FOR WIFI	6M.H6002.001
13	LVDS CABLE	50.H6002.009
14	CAMERA 2M	57.H6002.001
15	SPEAKER L+R	23.H6002.002
16	DOCKING BOARD FFC	50.H6002.002
17	DOCKING BOARD	55.H6002.001
18	MAINBOARD	MB.70500.041



# LCD Exploded Diagram

---



---

**Figure 6-3. LCD Exploded Diagram**

**Table 6-3. LCD Exploded Diagram**

No.	Description	P/N
1	BEZEL	60.H6002.004
2	LCD Panel w/control Board	6M.H6002.001

# FRU List

Table 6-4. FRU List

Category	Description	P/N
<b>ADAPTER</b>		
	Adapter PHIHONG 18W 12V/1.5A Black PSA18R-120P(AI)-R LF	AP.0180P.002
	Adapter PHIHONG 18W 12V/1.5A 1.1x3.0x7.5 Black PSA18R-120P(AI)-R, w/i 150cm cable LF	AP.0180P.003
	Adapter PHIHONG 18W 12V/1.5A Black PSA18R-120P(AI)-R LF	AP.0180P.002
<b>BATTERY</b>		
	Battery SIMPLO BAT-1010 Polymer 2S1P LGC 2 Cell 3260mAh Main COMMON BAT-1010	BT.00207.001
	Battery SANYO BAT-1010 Polymer 2S1P SANYO 2 Cell 3260mAh Main COMMON	BT.00203.002
	Battery SIMPLO BAT-1010 Polymer 2S1P LGC 2 Cell 3260mAh Main COMMON BAT-1010	BT.00207.001
	Battery SANYO BAT-1010 Polymer 2S1P SANYO 2 Cell 3260mAh Main COMMON	BT.00203.002
<b>BOARD</b>		
	DOCKING BOARD	55.H6002.001
	USB BOARD	55.H6002.002
	ERICSSON F5521GW	LC.21300.056
	3G CARD Huawei EM770W-Rev2	LC.21300.066
	HUAWEI EM820W	LC.21300.068
	Huawei EM770W-Rev3	LC.21300.073
	Ericsson F5521gw-TAB	LC.21300.074
	F5521gw-TAB-AT&T	LC.21300.075




**Table 6-4. FRU List (Continued)**

Category	Description	P/N
<b>CABLE</b>		
	DC-IN CABLE	50.H6002.001
	DOCKING BOARD FFC	50.H6002.002
	USB BOARD FFC	50.H6002.003
	TOUCH PANEL CABLE	50.H6002.004
	EXTERNAL HDMI CABLE	XZ.70200.117
	EXTERNAL USB CABLE	XZ.70200.115
	AC CLIP 18W -EU	27.L0302.001
	AC CLIP 18W -US	27.L0302.002
	AC CLIP 18W -CN	27.L0302.003
	AC CLIP 18W -UK	27.H6002.001
	AC CLIP 18W -AU	27.H6002.002
	AC CLIP 18W -ARG	27.H6002.003
	AC CLIP 18W -BRZ	27.H6002.004
	ANTENNA WLAN	50.H6002.005
	ANTENNA 3G-MAIN	50.H6002.006
	ANTENNA 3G-AUX	50.H6002.007

**Table 6-4. FRU List (Continued)**

Category	Description	P/N
	ANTENNA GPS	50.H6002.008
	ANTENNA GPS	50.H7F02.001
	LVDS CABLE	50.H6002.009
<b>CASE/COVER/BRACKET ASSEMBLY</b>		
	LOWER CASE INCL. CAMERA GLASS FOR 3G	60.H6002.001
	LOWER CASE INCL. CAMERA GLASS FOR W/O 3G	60.H6002.003
	LOWER CASE ASSY - MAYA, GW FOR 3G	60.H7S02.001
	LOWER CASE ASSY - MAYA, GW FOR WIFI	60.H7F02.001
	CAMERA GLASS FOR 5M CAMERA	60.H6002.002
	CAMERA GLASS	60.H7F02.002
	SIM CARD DOOR	42.H6002.002
	SIM CARD DOOR	42.H7F02.001
	CAMERA HOLDER FOR 5M CAMERA	42.H6002.001
	CAMERA HOLDER FOR 5M CAMERA	42.H7F02.002
	LCD SUPPORT PLATE FOR W/O 3G	33.H6002.001
	LCD SUPPORT PLATE FOR 3G	33.H6M02.001
	LCD SUPPORT PLATE FOR WIFI	33.H7F02.001
	LCD SUPPORT PLATE FOR 3G	33.H7Q02.001
	USB SUPPORT PLATE	33.H6002.002
	LCD BEZEL FOR WIFI	60.H6002.004
	LCD BEZEL FOR 3G	60.H6P02.001
<b>IC</b>		
	IC Adata Memory 13021743 (with Jewel Box and SD Adapter) (with samsungMMAGR02GUECA-2MB00)	IC.0200C.004
	IC Adata Memory 13021749(RUS Navitel) with Jewel Box and SD Adapt	IC.0200C.005
	IC Adata Memory 13021748 (UKR Navitel) with Jewel Box and SD Adapt	IC.0200C.006
	IC Adata Memory 8GB 13031505 intel L73A 25nm 32Gb MLC	IC.0800C.003

**Table 6-4. FRU List (Continued)**

Category	Description	P/N
	IC SanDisk Memory SDSDQ-2048 2GB Micro SD with Jewel Box and SD Adapter	IC.0200B.002
	IC SanDisk Memory SDSDQ-8192 8GB Micro SD with Jewel Box and SD Adapter	IC.0800B.002
	IC Kingston Memory SDC4/8GB 33 (with jewel box and adaptor) Toshiba NAND	IC.0800D.003
	IC Kingston Memory SDC/2GB 94 (with jewel box and adaptor) Toshiba NAND	IC.0200D.002
	IC Elpida Memory 168b PoP EDB8132B2PB-6D-F 40nm 8Gb	IC.0800E.001
	IC Hynix Memory H8TJR00X0MLR-0YM 44nm	IC.0080H.002
	eMMC SanDisk Memory eMMC SDIN4C2-16G 32nm	IC.0160B.001
	IC SanDisk Memory SDIN4E2-32G 43nm	IC.0320B.001
<b>LCD</b>		
	ASSY LCD TOUCH MODULE 10.1 FOR WIFI	6M.H6002.001
	ASSY LCD TOUCH MODULE 10.1 FOR 3G	6M.H6002.002
	ASSY LCD TOUCH MODULE 10.1 MAYA FOR WIFI	6M.H7F02.001
	ASSY LCD TOUCH MODULE 10.1 MAYA FOR 3G	6M.H7Q02.001
	LED LCD AUO 10.1" WXGA Glare B101EW05 0A LF 300nit 25ms w/TP (Cando + ATMEL, AUO TTL solution)	LK.10105.008
<b>DIGITAL LIGHT DEVICE</b>		
	CAMERA 2M	57.H6002.001
	CAMERA 5M	57.H6002.002
	CAMERA 5M-11P2BA501	57.H6002.003
	CAMERA 5M	57.H7F02.001

**Table 6-4. FRU List (Continued)**

Category	Description	P/N
<b>MAINBOARD</b>		
	Mainboard A501_16s Nvidia Tegra 250, W/3G&CPU&RAM	MB.70500.041
	Mainboard A501_32s Nvidia Tegra 250, W/3G&CPU&RAM	MB.70500.042
	Mainboard A500_16s Nvidia Tegra 250, W/O 3G W/CPU&RAM	MB.H6000.001
	Mainboard A500_32s Nvidia Tegra 250, W/O 3G W/CPU&RAM	MB.H6L00.001
	Mainboard A501_64s Nvidia Tegra 250, Rev 3.0, W/3G&CPU&RAM	MB.70500.045
	Mainboard A500_64s Nvidia Tegra 250 Rev 3.0, W/O3G W/CPU&RAM	MB.H7J00.002
	Mainboard A500_16s Nvidia Tegra 250 Rev 3.0, W/O 3G W/CPU&RAM	MB.H6000.002
	Mainboard A500_32s Nvidia Tegra 250 Rev 3.0, W/O 3G W/CPU&RAM	MB.H6L00.002
<b>SPEAKER</b>		
	MIC SET	23.H6002.001
	SPEAKER L+R	23.H6002.002
<b>MISCELLANEOUS</b>		
	LCD PANEL CONDUCTIVE TAPE	47.H6002.003
	ANTI-TEAR LABEL	47.H6002.004
	ANTI-TEAR LABEL - Maya GW	47.H7F02.001
	CAMERA FLASH LIGHT MYLAR	47.H7Q02.001
	SPEAKER SUPPORT MYLAR-R	47.H7F02.002
	SPEAKER SUPPORT MYLAR-L	47.H7F02.003
	LCD BEZEL ADHESIVE	47.H7F02.004
	DOCKING PCB SPONGE UP	47.H7F02.005
	DOCKING PCB SPONGE LOW	47.H7F02.006
	TS PCB SPONGE	47.H7F02.007
	MB SPONGE	47.H7F02.008

**Table 6-4. FRU List (Continued)**

<b>Category</b>	<b>Description</b>	<b>P/N</b>
	CAMERA HOLDER SPONGE	47.H7F02.009
	SPEAKER SPONGE	47.H7F02.010
	POWER SW RUBBER	47.H7F02.011

# Screw List

---

Table 6-5. Screw List

Category	Description	P/N
<b>SCREW</b>		
	SCREW 2.0D 3.0L K 4.6D ZK NL CR3	86.H6002.002
	SCREW 2D 4.0L K 4.6D NI NL	86.H6002.001
	SCREW M M 1.6D 5L K 2.8D 0.5T NI NL	86.H7F02.001





# CHAPTER 7

## Model Definition and Configuration

TP-A60W.....7-3

# Model Definition and Configuration

## TP-A60W

**Table 7-1. RO, NS & Description**

Model	Country	P/N	RO	NS	Description
TP-A60	CA	XE.H7FPN.002	PA	AAC	TP-A60 Tablet None PA_GW_GEN1 AndroidCA-GW-Tab-1 US- Black WiFi only_16G N N
TP-A60	CA	XE.H7GPN.002	PA	AAC	TP-A60 Tablet None PA_GW_GEN1 AndroidCA-GW-Tab-1 US- Black WiFi only_32G N N
TP-A60	ES	XE.H7FPN.003	PA	AAC	TP-A60 Tablet PA_GW_GEN3 AndroidLatin-GW-Tab-1 USEU Black WiFi only_16G N N N
TP-A60	ES	XE.H7GPN.003	PA	AAC	TP-A60 Tablet PA_GW_GEN3 AndroidLatin-GW-Tab-1 USEU Black WiFi only_32G N N N
TP-A60	HK	XE.H7FCN.001	CHINA	AFE	TP-A60 Tablet AAP_GW_GEN4 AndroidHK--GW-Tab-1 UK- Black WiFi only_16G
TP-A60	HK	XE.H7GCN.001	CHINA	AFE	TP-A60 Tablet AAP_GW_GEN4 AndroidHK--GW-Tab-1 UK- Black WiFi only_32G
TP-A60	US	XE.H7FPN.001	PA	AAC	TP-A60 Tablet PA_GW_GEN2US AndroidUSA-GW-Tab-1 US- Black WiFi only_16G
TP-A60	US	XE.H7GPN.001	PA	AAC	TP-A60 Tablet PA_GW_GEN2US AndroidUSA-GW-Tab-1 US- Black WiFi only_32G

**Table 7-2. BOM Name, CPU & Memory 1**

Model	Country	P/N	BOM Name	CPU	Memory1
TP-A60	CA	XE.H7FPN.002	TP-A60_16b	NV-TEGRA250	eMMC16GB
TP-A60	CA	XE.H7GPN.002	TP-A60_32b	NV-TEGRA250	eMMC32GB
TP-A60	ES	XE.H7FPN.003	TP-A60_16b	NV-TEGRA250	eMMC16GB
TP-A60	ES	XE.H7GPN.003	TP-A60_32b	NV-TEGRA250	eMMC32GB
TP-A60	HK	XE.H7FCN.001	TP-A60_16b	NV-TEGRA250	eMMC16GB
TP-A60	HK	XE.H7GCN.001	TP-A60_32b	NV-TEGRA250	eMMC32GB

**Table 7-2. BOM Name, CPU & Memory 1 (Continued)**

Model	Country	P/N	BOM Name	CPU	Memory1
TP-A60	US	XE.H7FPN.001	TP-A60_16b	NV-TEGRA250	eMMC16GB
TP-A60	US	XE.H7GPN.001	TP-A60_32b	NV-TEGRA250	eMMC32GB

**Table 7-3. 3G & Communication**

Model	Country	P/N	3G	Communication
TP-A60	CA	XE.H7FPN.002	N	WiFi
TP-A60	CA	XE.H7GPN.002	N	WiFi
TP-A60	ES	XE.H7FPN.003	N	WiFi
TP-A60	ES	XE.H7GPN.003	N	WiFi
TP-A60	HK	XE.H7FCN.001	N	WiFi
TP-A60	HK	XE.H7GCN.001	N	WiFi
TP-A60	US	XE.H7FPN.001	N	WiFi
TP-A60	US	XE.H7GPN.001	N	WiFi

**Table 7-4. Battery & Adapter**

Model	Country	P/N	Battery	Adapter
TP-A60	CA	XE.H7FPN.002	2CELL3.26	18W
TP-A60	CA	XE.H7GPN.002	2CELL3.26	18W
TP-A60	ES	XE.H7FPN.003	2CELL3.26	18W
TP-A60	ES	XE.H7GPN.003	2CELL3.26	18W
TP-A60	HK	XE.H7FCN.001	2CELL3.26	18W
TP-A60	HK	XE.H7GCN.001	2CELL3.26	18W
TP-A60	US	XE.H7FPN.001	2CELL3.26	18W
TP-A60	US	XE.H7GPN.001	2CELL3.26	18W

# CHAPTER 8

## Test Compatible Components

---

**Android OS Environment Test. . . . . 8-4**  
TP-A60W/ TP-A60G . . . . . 8-4

# Test Compatible Components

---

This computer's compatibility is tested and verified by Acer's internal testing department. All of its system functions are tested under Android OS environment.

Refer to the following lists for components, adapter cards, and peripherals which have passed these tests. Regarding configuration, combination and test procedures, please refer to the Gateway TP-A60W/ TP-A60G. Compatibility Test Report released by the Acer Mobile System Testing Department.



# Android OS Environment Test

## TP-A60W/ TP-A60G

Table 8-1. TP-A60W/ TP-A60G

Vendor	Type	Description	Part No.
<b>3G</b>			
60027216 ERICSSON	F5521gw-TAB	Ericsson F5521gw-TAB	LC.21300.074
<b>Accessory</b>			
10001012 COMPAL	Micro USB cable	Acer Micro USB cable Micro USB cable_Picasso/VanGogh	XZ.70200.115
<b>Adapter</b>			
60014287 PHIHONG	18W	Adapter PHIHONG 18W 12V/1.5A Black PSA18R-120P(AI)-R LF	AP.0180P.002
<b>Battery</b>			
60001921 SANYO	2CELL3.26	Battery SANYO BAT-1010, for new 2nd IC R5461K205AG Polymer 2S1P SANYO 2 Cell 3260mAh Main COMMON	BT.00203.009
60001921 SANYO	2CELL3.26	Battery SANYO BAT-1010 Polymer 2S1P SANYO 2 Cell 3260mAh Main COMMON	BT.00203.002
60001921 SANYO	2CELL3.26	Battery SANYO BAT-1010,for new 2nd IC R5461K204AG Polymer 2S1P SANYO 2 Cell 3260mAh Main COMMON	BT.00203.008
60001921 SANYO	2CELL3.26	Battery SANYO BAT-1010, for new 2nd IC 8253CAI Polymer 2S1P SANYO 2 Cell 3260mAh Main COMMON	BT.00203.007
60002162 SIMPLO	2CELL3.26	Battery SIMPLO BAT-1010, for new protection IC Polymer 2S1P LGC 2 Cell 3260mAh Main COMMON	BT.00207.002
60002162 SIMPLO	2CELL3.26	Battery SIMPLO BAT-1010 Polymer 2S1P LGC 2 Cell 3260mAh Main COMMON BAT-1010	BT.00207.001
<b>CPU</b>			
60001915 NVIDIA	NV-TEGRA250	HH CPU nVidia Tegra 250 BGA 664 1GHz	CU.25007.001

**Table 8-1. TP-A60W/ TP-A60G (Continued)**

Vendor	Type	Description	Part No.
<b>Front Camera</b>			
10001044 CHICONY	Camera Module	Camera Module CHICONY 2M FF CBFA233 FPC Micro SOC2031 MIPI COB	QM.02M06.001
<b>LCD</b>			
60003316 AUO	H10.1WXGA w/TP	LED LCD AUO 10.1" WXGA Glare B101EW05 0A LF 300nit 25ms w/TP (Cando + ATMEL, AUO TTL solution)	LK.10105.008
<b>Main Camera1</b>			
10001023 LITE-ON	Camera Module	Camera Module LITEON 5M AF 10P1SA505 FPC OV OV5650 MIPI CSP	QM.05M05.004
<b>Memory</b>			
10001079 SYNNEX	eMMC16GB	eMMC SanDisk Memory eMMC SDIN4C2-16G 32nm	IC.0160B.001
10001079 SYNNEX	eMMC32GB	IC SanDisk Memory SDIN4E2-32G 43nm	IC.0320B.001
60002045 HYNIX	LPDDR2	IC Hynix Memory H8TJR00X0MLR-0YM 44nm	IC.0080H.002
60003533 YOSUN	eMMC16GB	IC Samsung Memory KLMAG4FEJA-A001 27nm v4.41	IC.01609.004
60003533 YOSUN	eMMC32GB	IC Samsung Memory KLMBG8FEJA-A001	IC.03209.002
60003533 YOSUN	eMMC64GB	IC Samsung Modem KLMCGAFEJA-B001	IC.06409.001
60004668 ELPIDA	LPDDR2	IC Elpida Memory 168b PoP EDB8132B2PB-6D-F 40nm 8Gb	IC.0800E.001
60004830 SYNNEX HK	eMMC64GB	IC SanDisk Memory SDIN5F1-64G TLC	IC.0640B.001
60035660 KINGSTON	eMMC16GB	IC Kingston Memory KE4BT4B6A 4.41	IC.0160D.001
60035660 KINGSTON	eMMC32GB	IC Kingston Memory KE4BT5D6A v4.41	IC.0320D.001
<b>Wifi Module</b>			
PLM00016 Azurewave	WiFi Module	WiFi Module AZUREWAVE 802.11n Bluetooth FM AW-NH611 802.11bgn single band	QF.11N0Z.002



# CHAPTER 9

## Online Support Information

---

**Introduction . . . . .9-3**

# Online Support Information

---

## Introduction

---

This section describes online technical support services available to help users repair their Acer Systems.

For distributors, dealers, ASP or TPM, please refer the technical queries to a local Acer branch office. Acer Branch Offices and Regional Business Units may access our website. However some information sources will require a user i.d. and password. These can be obtained directly from Acer CSD Taiwan.

Acer's Website offers convenient and valuable support resources.

In the Technical Information section users can download information on all of Acer's Notebook, Desktop and Server models including:

- Service guides for all models
- Bios updates
- Software utilities
- Spare parts lists
- TABs (Technical Announcement Bulletin)

For these purposes, we have included an Acrobat File to facilitate the problem-free downloading of our technical material.

Also contained on this website are:

- Detailed information on Acer's International Traveller's Warranty (ITW)
- Returned material authorization procedures
- An overview of all the support services we offer, accompanied by a list of telephone, fax and email contacts for all technical queries.

We are always looking for ways to optimize and improve our services, so do not hesitate to direct any suggestions or comments to us.

